

2025 / 2026  
INTERNATIONAL EDITION



Bemis operates a modern production facility in the Bursa Organized Industrial Zone, with a closed area of 16,000 square meters. With 100% domestic production, the company manufactures 7,000 types of industrial electrical materials.

Holding ISO 9001-2015 Quality Management System certification along with CE, TSE, GOST-R, UKRSEPRO, and TÜV quality certificates, Bemis maintains its leadership in the sector with its skilled and experienced team.

As part of its structured efforts toward becoming a global brand, Bemis continues to advance confidently towards its goals.

With its registered slogan, "Quality is a reflection of respect!", Bemis remains committed to producing high-quality products and providing reliable after-sales services.

Through its export activities, Bemis is not only a recognized brand in the domestic market but also steadily making a name for itself in the global market.

As Turkey's market leader in its field, Bemis manufactures plastic, metal, and rubber plugs and sockets in compliance with different standards and power requirements.

In addition to industrial plugs and sockets, the company provides technical solutions across all industrial sectors with a wide range of products, including plastic distribution panels (combination boxes), plastic and metal junction boxes, plastic enclosures, plastic and metal push-button boxes, plastic switch boxes, plastic and metal cable reels, portable work lamps, safety transformer lighting fixtures, automatic cable winding energy transfer systems, power boxes, and panels.

Beyond the domestic market, Bemis also serves the European market through its branch in Poland and exports to countries including Russia, Egypt, Algeria, Iran, Azerbaijan, Portugal, Ukraine, Bulgaria, Romania, Serbia, France, Germany, Poland, Nigeria, Belarus, Kazakhstan, Iraq, Turkmenistan, Uzbekistan, Kyrgyzstan, Tajikistan, Sweden, Mongolia, South Africa, Kosovo, Tunisia, Jordan, Morocco, Chile, Switzerland, Kuwait, Lebanon, Lithuania, Latvia, Estonia, Norway, India, Spain, Georgia, North Macedonia, Bosnia and Herzegovina, Hungary, Saudi Arabia, Pakistan, Libya, and Qatar.

Our core values are a principled approach, systematic marketing and sales strategies, and dedicated after-sales service. By continuously monitoring customer satisfaction through annual surveys, we identify areas for improvement and take necessary steps to enhance our products and services accordingly.

Bemis continuously improves its products based on feedback received through its network of 110 select dealers. Prioritizing customer satisfaction, the company places great emphasis on R&D activities, designing products that are both practical and highly functional.

#### Our Mission

To continuously develop an aesthetic and safe product range that meets the needs of our stakeholders.

#### Our Vision

To become a globally recognized brand that leads the industry through innovation and quality.



# BEMIS TEST LABORATORY



Glowing Wire



Aging Test

## Documents and Certificates





*Ports and Shipyards*



# *Technical Solutions in Industry*



*Defense Industry*



*Mines*



**E-V Charge**



**Automotive & Caravan**

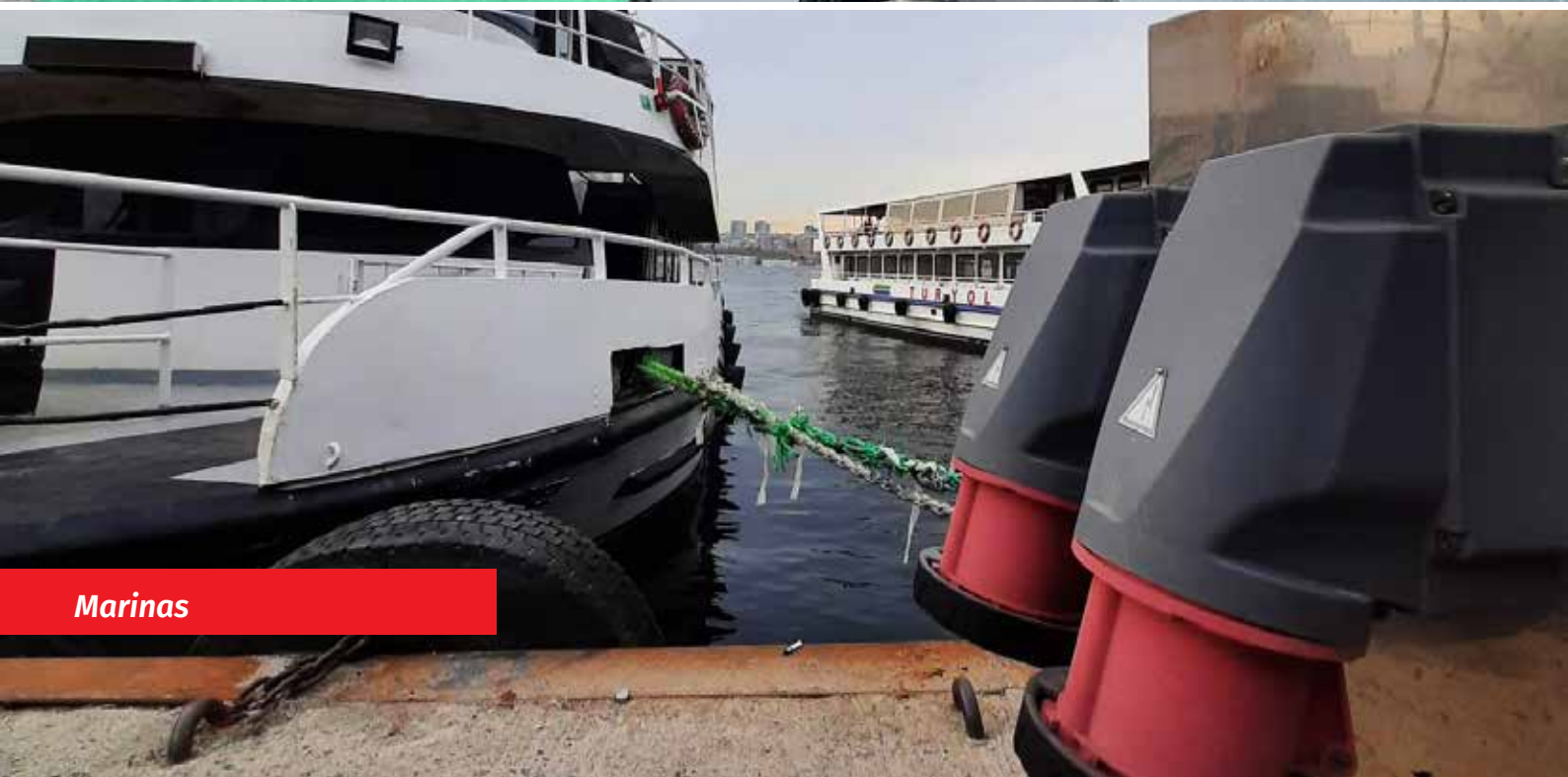

**Marinas**

BRAND  
NEW

**ELECTRIC VEHICLE CHARGING PRODUCTS Series**



AC Wallbox

Page 09



Mobile  
Charger



Charging  
Socket

Charging Set

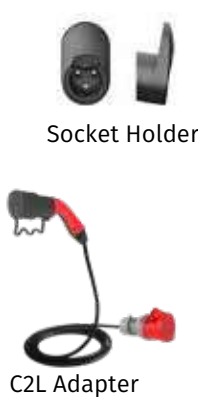

Socket Holder

C2L Adapter



V2L Adapter

V2L Adapter



Pedestal

**V20 COMBINATION Series**

The V20 Series Combination Boxes, available in ABS and halogen-free options, offer IP44 and IP67 protection ratings with a capacity of up to 20 circuit breakers. Designed for a wide range of applications, from industrial facilities and construction sites to power transmission lines, shipyards, and ports, these boxes ensure reliable energy distribution in various environments. With their aesthetic design, high protection standards, and easy installation features, they provide a safe and efficient power distribution solution across all field applications.



Easy Installation Between L Profile  
Steel Construction

**Spirit Level Combination Series**

V10 - V12 - V15 - V17 - V20 - V26

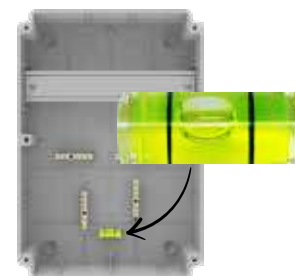

The application, which was first implemented in Turkey, provides a more organized assembly opportunity for end users.

**ATEX EX-PROOF JUNCTION & BUTTON Series**



Page 125

**ABS JUNCTION BOXES AND ALUMINUM JUNCTION BOXES**

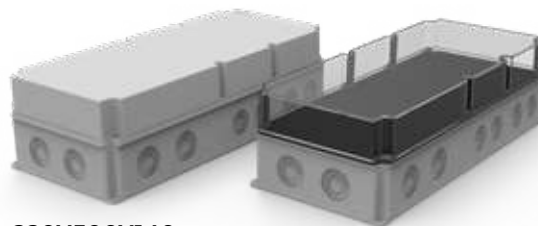

220X500X140



100X100X90



110X180X70

Page 115

2 YEAR WARRANTY

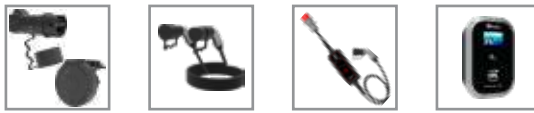

## E-V Charge Series

Electric Vehicle Charging Products Series

5 YEAR WARRANTY



## Rubber - Plastic Plug & Socket

Monophase - Caravan - Arc Welding

5 YEAR WARRANTY



## CEE Norm Plug & Socket Series

16A - 32A - 63A - 125A - 160A

5 YEAR WARRANTY



## CEE Norm Low Voltage Series

24 Volt Low Voltage Plug & Socket

5 YEAR WARRANTY



## TriBox

16A - 32A

5 YEAR WARRANTY



## PolyBox

16A - 32A

2 YEAR WARRANTY



## PowerBox

2 YEAR WARRANTY



## Interlock

16A - 32A - 63A

2 YEAR WARRANTY

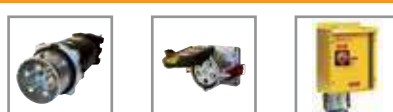

## High Amperage

200A - 250A - 350A - 400A

2 YEAR WARRANTY

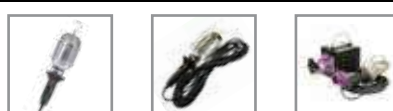

## Lighting

Transformer and Hand Lamp

5 YEAR WARRANTY



## Combinations

V5 - V7 - V10 - V12 - V15 - V17 - V20 - V26

5 YEAR WARRANTY



## Enclosure Box

Aluminum - Plastic

5 YEAR WARRANTY



## Button Box

Aluminum - Plastic

5 YEAR WARRANTY



## EX-Proof Enclosure & Button Box

Aluminum

5 YEAR WARRANTY



## Cable Reel

Metal - Plastic

2 YEAR WARRANTY



## Spare Parts





2 YEAR  
WARRANTY

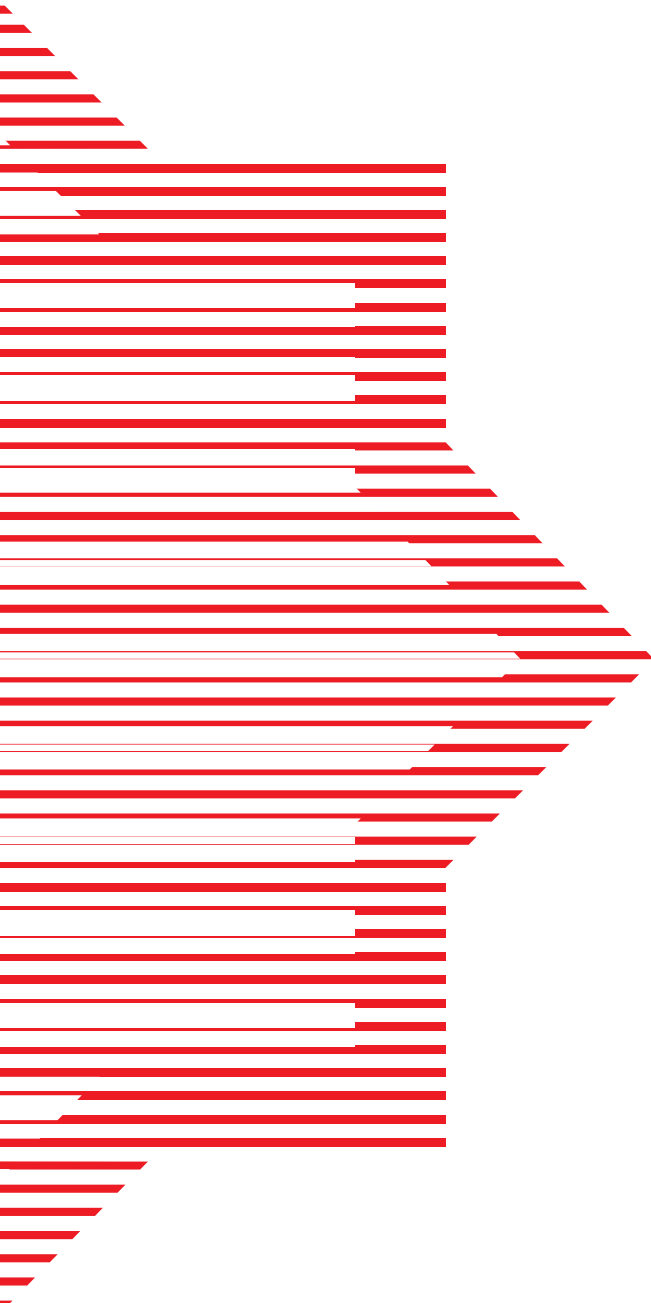

*E-V Charge Series*



*Chargers*



*Charging Plugs and Sockets*



*Adapters and Accessories*

**BRAND  
NEW**



## Electric Vehicle Charging Plugs and Sockets

Product Code	Descriptions	Cable Length	Phase	Amper
BEV-3016-4320	Panel Socket	4 Screw Mounted	Monophase	16/32/63A.
BEV-3016-4310	Panel Socket	3 Screw Mounted	Monophase	16/32/63A.
BEV-5032-4320	Panel Socket	4 Screw Mounted	Threephase	16/32/63A.
BEV-5032-4310	Panel Socket	3 Screw Mounted	Threephase	16/32/63A.
BEV-3020-1205	Charging Set With Cable	5m	Monophase	20A
BEV-3020-1208	Charging Set With Cable	8m	Monophase	20A
BEV-3032-1205	Charging Set With Cable	5m	Monophase	32A
BEV-3032-1208	Charging Set With Cable	8m	Monophase	32A
BEV-5020-1205	Charging Set With Cable	5m	Threephase	20A
BEV-5020-1208	Charging Set With Cable	8m	Threephase	20A
BEV-5032-1205	Charging Set With Cable	5m	Threephase	32A
BEV-5032-1208	Charging Set With Cable	8m	Threephase	32A
BEV-3020-2205	Charging Set With Cable	5m	Monophase	20A
BEV-3020-2208	Charging Set With Cable	8m	Monophase	20A
BEV-3032-2205	Charging Set With Cable	5m	Monophase	32A
BEV-3032-2208	Charging Set With Cable	8m	Monophase	32A
BEV-5020-2205	Charging Set With Cable	5m	Threephase	20A
BEV-5020-2208	Charging Set With Cable	8m	Threephase	20A
BEV-5032-2205	Charging Set With Cable	5m	Threephase	32A
BEV-5032-2208	Charging Set With Cable	8m	Threephase	32A
BAK-8000-0000	Plug-Socket Charging Set Bag			



**32A PANEL SOCKET WITH 4 POINT CONNECTION**



**THREEPHASE 32A CHARGER SET WITH 5M CABLE**



**THREEPHASE 32A CHARGING SOCKET WITH 5M CABLE**



**CHARGING SET BAG**

# Electric Vehicle Chargers



BRAND  
NEW

Product Code	Descriptions	kW	Phase	Amper
BEV-2316-4302	Panel-Mounted Plug-and-Play Model 1 Charger Without Screen	7,4 kw	Monophase	32A
BEV-2516-4303	Panel-Mounted Plug-and-Play Model 1 Charger Without Screen	11 kw	Threephase	16A
BEV-2516-4304	Panel-Mounted Plug-and-Play Model 1 Charger Without Screen	22 kw	Threephase	32A
BEV-1316-4302	Panel-Mounted Model 2 Charger Plus With Screen	7,4 kw	Monophase	32A
BEV-1516-4303	Panel-Mounted Model 2 Charger Plus With Screen	11 kw	Threephase	16A
BEV-1516-4304	Panel-Mounted Model 2 Charger Plus With Screen	22 kw	Threephase	32A
BEV-2332-2352	Cable-End Plug Model 1 Charger Without Screen <b>(5m Cable)</b>	7,4 kw	Monophase	32A
BEV-2532-2353	Cable-End Plug Model 1 Charger Without Screen <b>(5m Cable)</b>	11 kw	Threephase	16A
BEV-2532-2354	Cable-End Plug Model 1 Charger Without Screen <b>(5m Cable)</b>	22 kw	Threephase	32A
BEV-1332-2352	Cable-End Plug Model 2 Charger Plus With Screen <b>(5m Cable)</b>	7,4 kw	Monophase	32A
BEV-1532-2353	Cable-End Plug Model 2 Charger Plus With Screen <b>(5m Cable)</b>	11 kw	Threephase	16A
BEV-1532-2354	Cable-End Plug Model 2 Charger Plus With Screen <b>(5m Cable)</b>	22 kw	Threephase	32A
BEV-3532-2354	Cable-End Plug Fully Commercial Model 3 Charger Pro With Screen <b>(5m Cable)</b>	22 kw	Threephase	32A
BEV-3516-4304	Panel-Mounted Fully Commercial Model 3 Charger Pro With Screen	22 kw	Threephase	32A

E-V CHARGER MODELS



**MODEL-1  
CHARGER**



**MODEL-2  
CHARGER +**



**MODEL-3  
CHARGER PRO**

Product Code	Descriptions	Cable Length	kW	Amper
BEV-1111-0001	Mini Mobile	5 metre	2,3 - 3,7 kw	10A - 16A
BEV-1221-0001	Mono Mobile	5 metre	3,7 - 7,4 kw	16A - 32A
BEV-2331-0001	Pro Mobile	5 metre	11 - 22 kw	16A - 32A

MOBILE CHARGER



**MODEL-1  
MINI MOBILE**



**MODEL-2  
MONO MOBILE**



**MODEL-3  
PRO MOBILE**

E-V Charge

**BRAND  
NEW**



## Electric Vehicle V2L Adapters

### What is a V2L Adapter Used For?

A V2L (Vehicle-to-Load) adapter enables energy output from an electric vehicle's battery, allowing external devices to be powered. It is particularly useful in emergencies or natural disasters. Additionally, it provides the capability for vehicle-to-vehicle charging, making it a versatile solution for mobile power needs.

Product Code	Descriptions
BKT-2102-2001	V2L Single Output Adapter
BEV2L-3201-3203	V2L Single Extension Socket Adapter (3mt Cable)
BEV2L-3202-3203	V2L 2 way Socket Extensions Adapter (3mt Cable)
BEV2L-3203-3203	V2L 3 way Socket Extensions Adapter (3mt Cable)

Single Output  
V2L Adapter



**BKT-2102-2001**

Single Socket  
Extension V2L Adapter



**BEV2L-3201-3203**

2 way Socket  
Extension V2L Adapter



**BEV2L-3202-3203**

3 way Socket  
Extension V2L Adapter



**BEV2L-3203-3203**

## Electric Vehicle C2L Adapters

### What is a C2L Adapter Used For?

A C2L (Charger-to-Load) adapter converts MOD 2 and MOD 3 AC charging stations into a MOD 1 (standard plug-socket) charging connection. This allows electric vehicles such as Citroën Ami, Amperio, Fiat Topolino, as well as electric bicycles, electric scooters, battery-powered cars, and other electric devices, to be charged using MOD 2 and MOD 3 AC charging stations, making charging more versatile and accessible.

Product Code	Descriptions
BEVC2L-3301-3603	C2L Single Extension Socket Adapter (3mt Cable)
BEVC2L-3302-3603	C2L 2 way Socket Extensions Adapter (3mt Cable)
BEVC2L-3303-3603	C2L 3 way Socket Extensions Adapter (3mt Cable)
BEVC2L-5305-3603	C2L 5/32A Socket Extensions Adapter (3mt Cable)

Single Socket  
Extension C2L Adapter



**BEVC2L-3301-3603**

2 way Socket  
Extension C2L Adapter



**BEVC2L-3302-3603**

3 way Socket  
Extension C2L Adapter



**BEVC2L-3303-3603**

5/32A. Socket  
Extension C2L Adapter



**BEVC2L-5305-3603**

Product Code	Descriptions
BKT-0108-2211	Cee Norm Adapter 3x2,5 Ttr 1/16A Plug - 5/16A Socket (30cm Cable)
BKT-0508-2211	Cee Norm Adapter 3x2,5 Ttr 3/16A Plug - 5/16A Socket (30cm Cable)
BKT-1008-2511	Cee Norm Adapter 5x2,5 Ttr 5/32A Plug - 5/16A Socket (30cm Cable)
BKT-0109-2211	Cee Norm Adapter 3x2,5 Ttr 1/16A Plug - 3/32A Socket (30cm Cable)
BKT-0111-2211	Cee Norm Adapter 3x2,5 Ttr 1/16A Plug - 5/32A Socket (30cm Cable)
BKT-0511-2211	Cee Norm Adapter 3x2,5 Ttr 3/16A Plug - 5/32A Socket (30cm Cable)
BKT-0711-2511	Cee Norm Adapter 5x2,5 Ttr 5/16A Plug - 5/32A Socket (30cm Cable)
BAK-8300-0000	Pedestal
BAK-8200-0000	Socket Holder



Pedestal  
**BAK-8300-0000**



Socket Holder  
**BAK-8200-0000**

5/16A Socket  
1/16A Plug



**BKT-0108-2211**

5/16A Socket  
3/16A Plug



**BKT-0508-2211**

5/16A Socket  
5/32A Plug



**BKT-1008-2511**

3/32A Socket  
1/16A Plug



**BKT-0109-2211**

5/32A Socket  
1/16A Plug



**BKT-0111-2211**

5/32A Socket  
3/16A Plug



**BKT-0511-2211**

5/32A Socket  
5/16A Plug



**BKT-0711-2511**

# MONOPHASE RUBBER GROUP SOCKETS

## 1/16A. (2P+E) 200/250V~

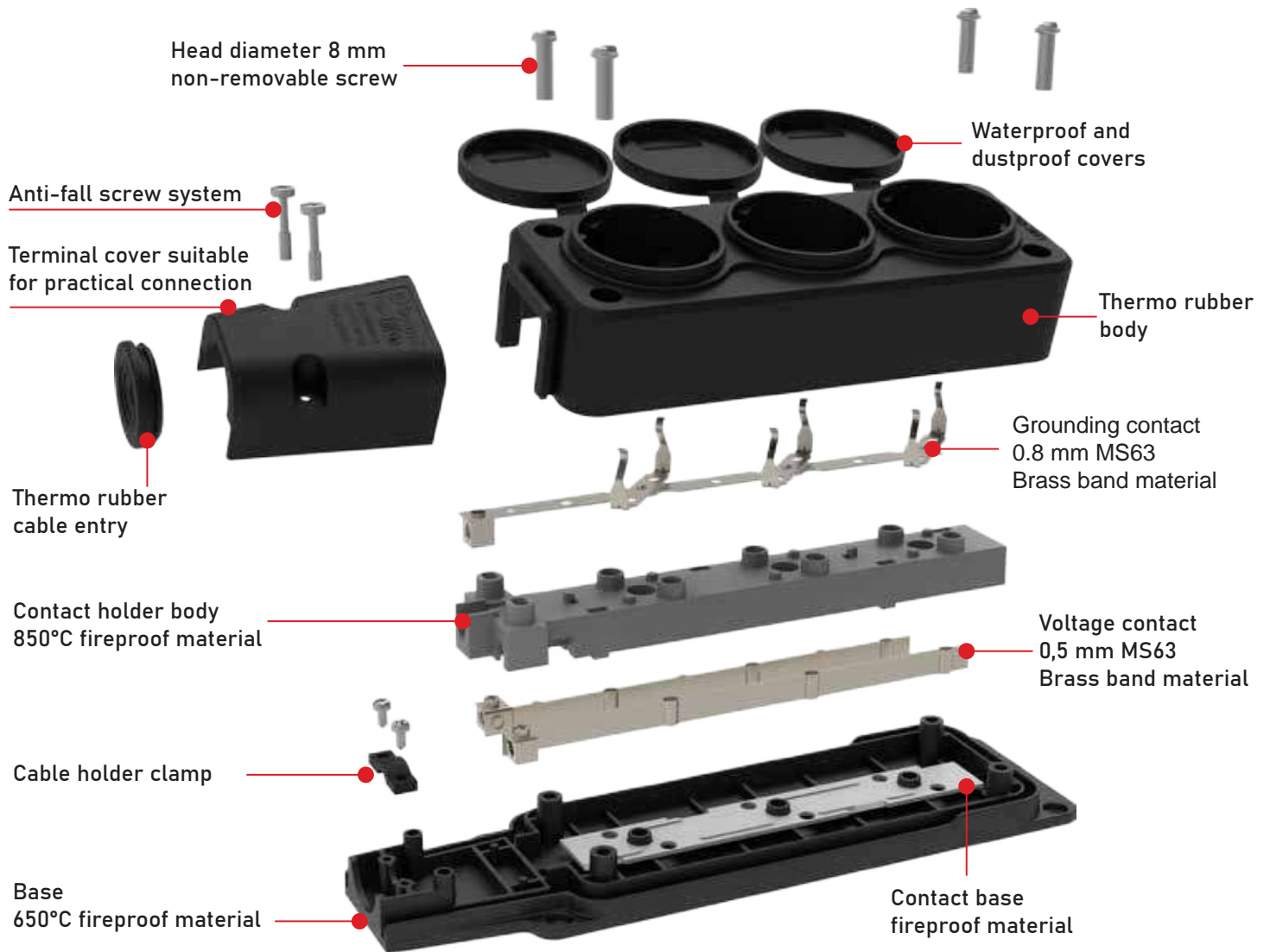

### COLOR OPTIONS



BV6-1402-3613



BV5-1402-3613



BV4-1402-3613



BV3-1402-3613



BV2-1402-3613



BV1-1402-3613



**5 YEAR  
WARRANTY**

## **Rubber - Plastic Plug & Socket**

*Monophase - Caravan - Arc Welding*



*Monophase Series*



*Caravan Series*



*Arc Welding Series*

Product Code	Descriptions	IP	Box	Pack
BK1-1402-2011	Straight Plug	IP44	30	360
BK1-1402-2311	Connector Socket	IP44	25	200
BK1-1402-3511	Surface Mounted Socket	IP54	12	144
BK1-1402-3612	2way Socket	IP54	8	96
BK1-1402-3613	3way Socket	IP54	7	84
BK1-1402-3614	4way Socket	IP54	8	64
BK1-1402-2022	Angled Plug	IP44	20	240
BK1-1402-2021	Handle Angled Plug	IP44	20	240



**French Type Monophase Rubber Series  
1x16A. (2P+E) 200/250V.**

Product Code	Descriptions	IP	Box	Pack
BK1-1402-2031	Straight Plug French Type	IP44	30	360
BK1-1402-2361	Connector Socket French Type	IP44	25	200
BK1-1402-3622	2way Socket French Type	IP54	8	96
BK1-1402-3623	3way Socket French Type	IP54	7	84
BK1-1402-3624	4way Socket French Type	IP54	8	64



**UPS Monophase Rubber  
1x16A. (2P+E) 200/250V.**

Product Code	Descriptions	IP	Box	Pack
BK1-1402-2031	UPS Straight Plug	IP44	30	360
BK1-1402-2042	UPS Angled Plug	IP44	20	240
BK1-1402-2041	UPS Handle Angled Plug	IP44	20	240





# Colorful Monophase Rubber Series

## 1x16A. (2P+E) 200/250V.



Product Code	Descriptions	IP	Box	Pack
BV2-1402-3511	Surface Mounted Socket (Blue)	IP54	12	144
BV3-1402-3511	Surface Mounted Socket (Yellow)	IP54	12	144
BV2-1402-3612	2way Socket (Blue)	IP54	8	96
BV3-1402-3612	2way Socket (Yellow)	IP54	8	96
BV1-1402-3613	3way Socket (Green)	IP54	7	84
BV2-1402-3613	3way Socket (Blue)	IP54	7	84
BV3-1402-3613	3way Socket (Yellow)	IP54	7	84
BV4-1402-3613	3way Socket (Orange)	IP54	7	84
BV5-1402-3613	3way Socket (Grey)	IP54	7	84
BV6-1402-3613	3way Socket (Red)	IP54	7	84
BV2-1402-3614	4way Socket (Blue)	IP54	8	64
BV3-1402-3614	4way Socket (Yellow)	IP54	8	64

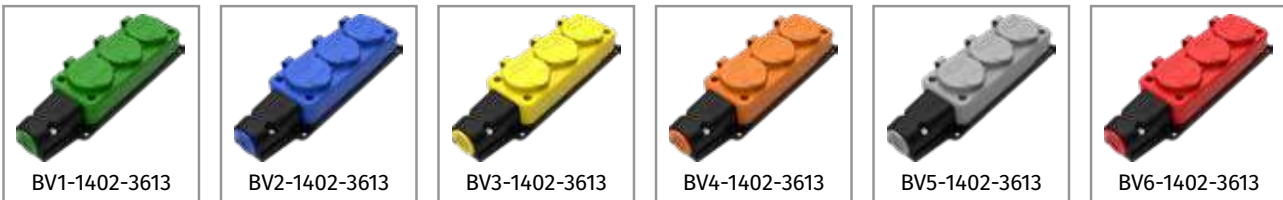

Product Code	Descriptions	IP	Box	Pack
BV1-1402-2011	Straight Plug (Green)	IP44	30	360
BV2-1402-2011	Straight Plug (Blue)	IP44	30	360
BV3-1402-2011	Straight Plug (Yellow)	IP44	30	360
BV4-1402-2011	Straight Plug (Orange)	IP44	30	360
BV5-1402-2011	Straight Plug (Grey)	IP44	30	360
BV6-1402-2011	Straight Plug (Red)	IP44	30	360

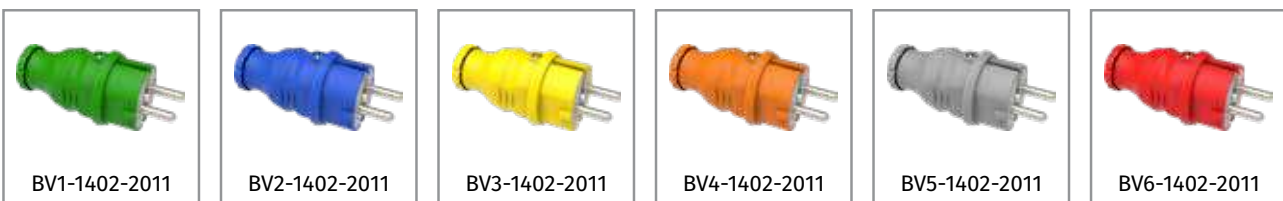

Product Code	Descriptions	IP	Box	Pack
BV1-1402-2311	Connector Socket (Green)	IP44	25	200
BV2-1402-2311	Connector Socket (Blue)	IP44	25	200
BV3-1402-2311	Connector Socket (Yellow)	IP44	25	200
BV4-1402-2311	Connector Socket (Orange)	IP44	25	200
BV5-1402-2311	Connector Socket (Grey)	IP44	25	200
BV6-1402-2311	Connector Socket (Red)	IP44	25	200



Note: Color products are produced to order

Product Code	Descriptions	IP	Box	Pack
BV1-1402-2021	Handle Angled Plug (Green)	IP44	20	240
BV2-1402-2021	Handle Angled Plug (Blue)	IP44	20	240
BV3-1402-2021	Handle Angled Plug (Yellow)	IP44	20	240
BV4-1402-2021	Handle Angled Plug (Orange)	IP44	20	240
BV5-1402-2021	Handle Angled Plug (Grey)	IP44	20	240
BV6-1402-2021	Handle Angled Plug (Red)	IP44	20	240

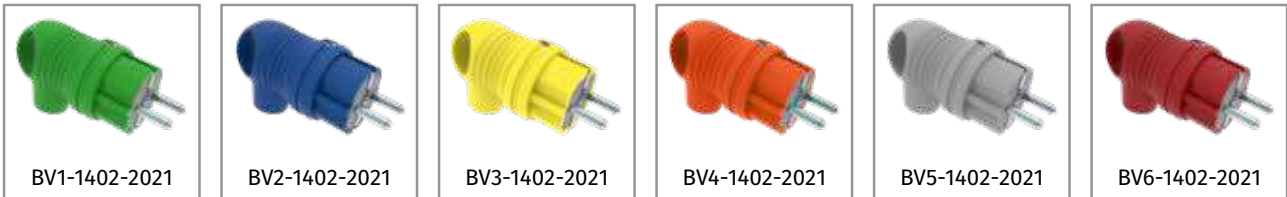

## UPS Colorful Monophase Rubber Plug 1x16A. (2P+E) 200/250V.

Product Code	Descriptions	IP	Box	Pack
BV1-1402-2031	UPS Straight Plug (Green)	IP44	30	360
BV2-1402-2031	UPS Straight Plug (Blue)	IP44	30	360
BV3-1402-2031	UPS Straight Plug (Yellow)	IP44	30	360
BV4-1402-2031	UPS Straight Plug (Orange)	IP44	30	360
BV5-1402-2031	UPS Straight Plug (Grey)	IP44	30	360
BV6-1402-2031	UPS Straight Plug (Red)	IP44	30	360

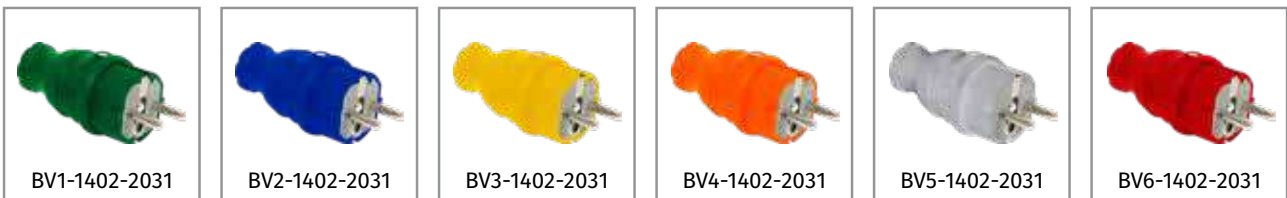

## UPS Colorful Monophase Rubber Handle Angled Plug 1x16A. (2P+E) 200/250V.

Product Code	Descriptions	IP	Box	Pack
BV1-1402-2041	UPS Handle Angled Plug (Green)	IP44	20	240
BV2-1402-2041	UPS Handle Angled Plug (Blue)	IP44	20	240
BV3-1402-2041	UPS Handle Angled Plug (Yellow)	IP44	20	240
BV4-1402-2041	UPS Handle Angled Plug (Orange)	IP44	20	240
BV5-1402-2041	UPS Handle Angled Plug (Grey)	IP44	20	240
BV6-1402-2041	UPS Handle Angled Plug (Red)	IP44	20	240



Note: Color products are produced to order



## MONOPHASE RUBBER PLUGS 1/16A. (2P+E) 200/250V~

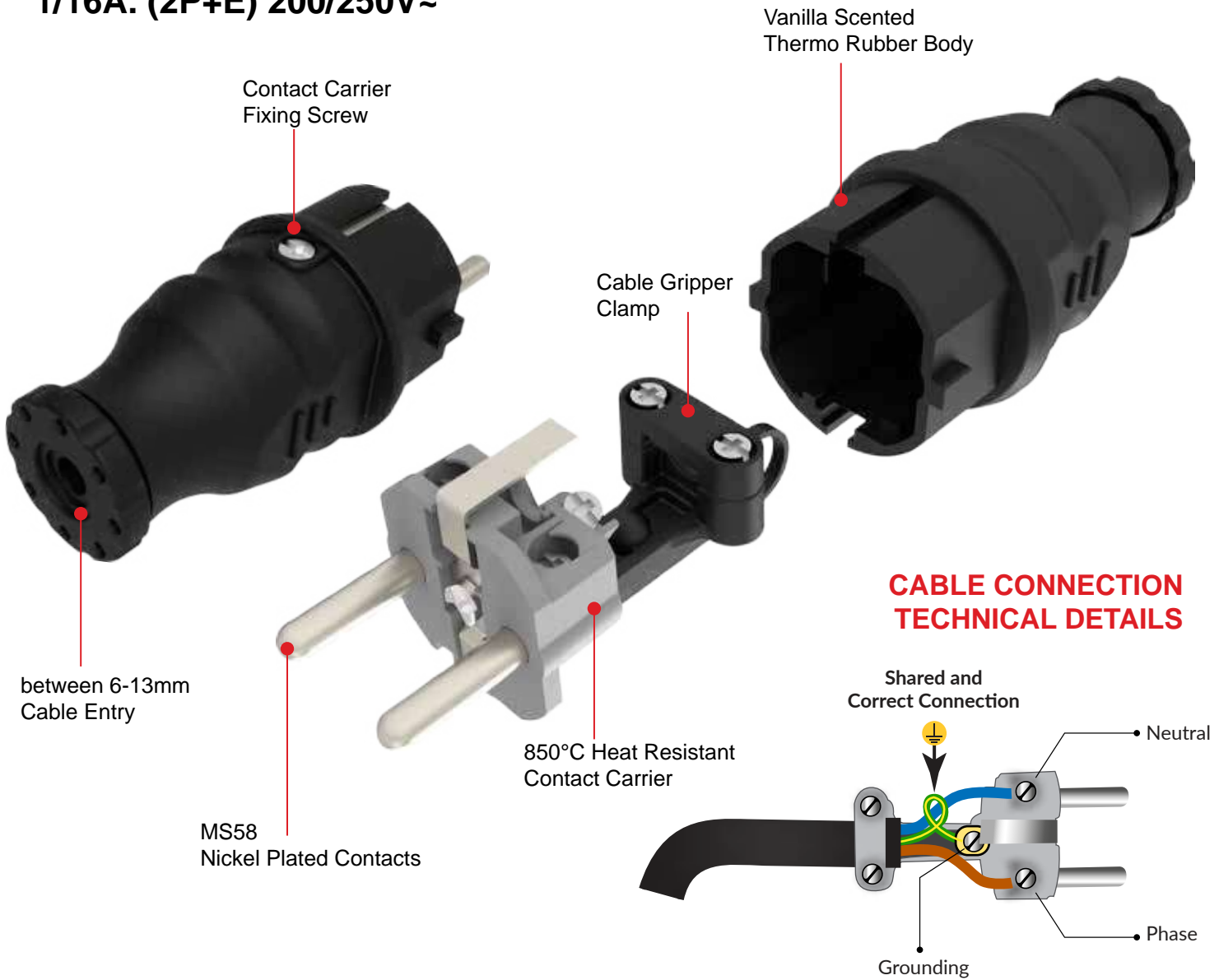

## COLOR OPTIONS

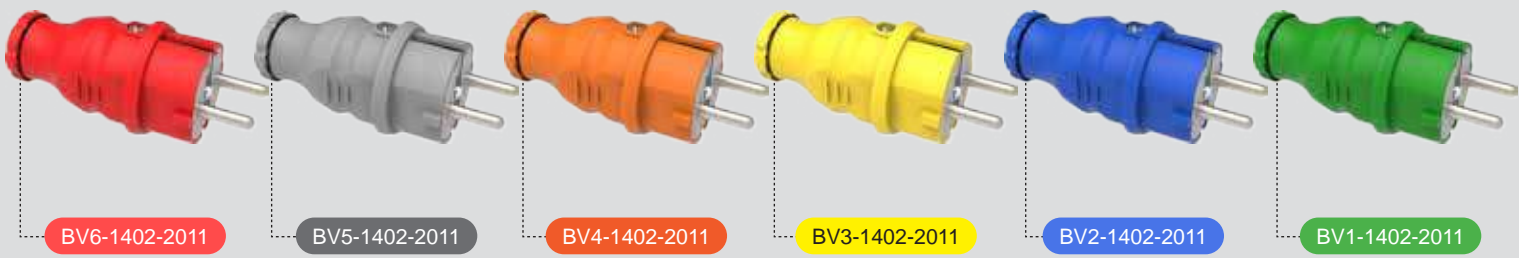



NO DRILL



NO SCREWDRIVER



NO SCREWS

## The first and only in the world. 16A. screwless panel socket



German and French type

### Very Practical, Screwless ASSEMBLY



In today's conditions, the shortage of technical staff, high man hour costs we manufacturers to make more practical, more robust designs. not compelled. In this context, we have done As a result of R&D studies, very serious we made progress. Although it is a small product 4 point assembly and after assembly After this product, which has difficulty in connecting the cable, we've solved both assembly challenges. Our new product screwless mounting and screwless It is very practical and convenient by providing cable connection. becomes more robust. Attention all users is presented.

# IP68 Monophase Series 1x16A. (2P+E) 200/250V.



Product Code	Descriptions	IP	Box	Pack
BS1-1402-7011	Straight Plug	IP68	10	80
BS1-1402-7311	Connector Socket	IP68	10	80
BS1-1402-7114	Panel Mounted Plug	IP68	8	96
BS1-1402-7510	Surface Mounted Socket with Screw Connection	IP68	6	48
BS1-1402-7511	Surface Mounted Socket with Quick Connect	IP68	6	48
BS1-1402-7210	Surface Mounted Plug	IP68	6	48
BS1-1402-7535	90° Angled Surface Socket	IP68	3	36
BS1-1402-7236	90° Angled Surface Plug	IP68	3	36
BS1-1402-7410	Screw Connected Panel Mounted Socket (without Child Protection Lock)	IP68	8	96
BS1-1402-7416	Quick Connect Panel Mounted Socket (Child Protection Unlocked)	IP68	8	96
BS1-1402-7417	Quick Connect Panel Mounted Socket (Childproof Lock)	IP68	8	96
BS1-1402-7440	Screwless Panel Socket with Screw Connection (No Child Protection Lock)	IP68	12	144
BS1-1402-7446	Quick Connect Screwless Panel Socket (Child Protection Unlocked)	IP68	12	144
BS1-1402-7476	Quick Connect Screwless Panel Socket (Child Protection Locked)	IP68	12	144

## Straight Plug



BS1-1402-7011

## Panel Mounted Plug



BS1-1402-7114

## 90° Angled Surface Plug



BS1-1402-7236

## Surface Mounted Plug



BS1-1402-7210

## Connector Socket



BS1-1402-7311

## 90° Angled Surface Socket



BS1-1402-7535

## Surface Mounted Socket with Screw Connection



BS1-1402-7510

## Surface Mounted Socket with Quick Connect



BS1-1402-7511

## Screw Connected Panel Mounted Socket



BS1-1402-7410

## Quick Connect Panel Mounted Socket



BS1-1402-7416

## Screwless Panel Socket with Screw Connection



BS1-1402-7440

## Quick Connect Screwless Panel Socket



BS1-1402-7446



Product Code	Descriptions	IP	Box	Pack
BP1-1402-2011	Straight Plug	IP44	35	420
BP1-1402-1311	Connector Socket	IP20	20	240
BP1-1402-2022	Angled Plug	IP44	35	420

Product Code	Descriptions	IP	Box	Pack
BY8-1402-2440	Screwless Panel Socket	IP44	30	360
BY8-1402-2445	UPS Screwless Panel Socket	IP44	30	360
BY8-1402-2700	Panel Socket (Horizontal Input)	IP44	30	360
BY8-1402-2705	Panel Socket (UPS - Horizontal Input)	IP44	30	360
BY8-1402-3510	Schuko Socket with Wall Cover	IP44	12	144
BY5-1402-2700	Panel Socket (Grey)	IP44	30	360
BY9-1402-2700	Panel Socket (Black)	IP44	30	360
BY8-1402-2720	UPS Panel Socket (Yellow)	IP44	30	360
BP1-1402-2510	Surface Mounted Socket	IP44	6	72
BY8-1402-3700	Panel Socket	IP54	25	300
BY9-1402-3700	Panel Socket (Black)	IP54	25	300
BY3-1402-3700	Panel Socket (Yellow)	IP54	25	300
BP1-1402-2410	Panel Mounted Socket	IP44	18	144

Product Code	Descriptions	IP	Box	Pack
BP1-1402-2013	Straight Plug	IP44	10	120
BP1-1402-2311	Connector Socket with Cover	IP44	10	120
BP1-1402-2413	Panel Mounted Socket (Small Cover)	IP44	10	120
BP1-1402-2512	Surface Mounted Socket	IP44	6	72
BP1-1402-2535	90° Angled Surface Socket	IP44	4	48

Product Code	Descriptions	IP	Box	Pack
BR1-1402-2711	Rail Socket	IP20	12	144
BR1-1402-2712	Rail Socket with Led	IP20	12	144
BR1-1402-2713	Rail Socket with French	IP20	12	144
BR1-1402-2714	Rail Socket French with Led	IP20	12	144

Product Code	Descriptions	IP	Box	Pack
BP1-1402-2031	UPS Straight Plug	IP44	35	420
BP1-1402-2042	UPS Angled Plug	IP44	35	420
BY2-1402-2011	Straight Plug (Blue)	IP44	35	420
BY2-1402-2031	UPS Straight Plug (Blue)	IP44	35	420
BY5-1402-2011	Straight Plug (Grey)	IP44	35	420
BY5-1402-2031	UPS Straight Plug (Grey)	IP44	35	420
BY2-1402-2022	Angled Plug (Blue)	IP44	35	420
BY2-1402-2042	UPS Angled Plug (Blue)	IP44	35	420

Note: Color products are produced to order

# Plastic Monophase Series

## 1x16A. (2P+E) 200/250V.

Product Code	Descriptions	IP	Box	Pack
BY8-1402-2446	Quick Connect Screwless Panel Socket (Child Protection Unlocked)	IP44	30	360
BY8-1402-2476	French Type Quick Connect Screwless Panel Socket (Child Protection Unlocked)	IP44	30	360
BY8-1402-2447	Quick Connect Screwless Panel Socket (Child Protection Locked)	IP44	30	360
BY8-1402-2477	French Type Quick Connect Screwless Panel Socket (Child Protection Locked)	IP44	30	360



## Rubber Arc Weld

### 200A-400A



Product Code	Descriptions	IP	Box	Pack
BK4-7501-2010	16/95mm <sup>2</sup> 200A. Plug	IP55	15	120
BK4-7501-2310	16/95mm <sup>2</sup> 200A. Connector Socket	IP55	15	120
BK4-7501-2410	16/95mm <sup>2</sup> 200A. Panel Mounted Socket	IP55	12	144
BK4-9501-2010	50/150mm <sup>2</sup> 400A. Plug	IP55	15	120
BK4-9501-2310	50/150mm <sup>2</sup> 400A. Connector Socket	IP55	15	120
BK4-9501-2410	50/150mm <sup>2</sup> 400A. Panel Mounted Socket	IP55	12	144





IP54



**BKT-0500-3000 (ABS)**  
3/16A. 220V. socket with cover



**BKT-0002-3001 (ABS)**  
LIGHTER + SATELLITE  
INPUT



**BKT-3000-3000 (ABS)** Empty



**BKT-0106-2000**  
(Polyamid 6)  
1/16A. Plug - 3/16A.  
ADAPTER SOCKET



**BKT-0502-2000**  
(Polyamid 6)  
3/16A. Plug - 1/16A.  
ADAPTER SOCKET



**BC1-1402-2870**  
(Polyamid 6)  
3/16A. 220V.

*Our cable mobile extension products are suitable for use in camping, boats and caravans.*



*Our range designed for camping, caravan and general mobile energy transfer. 100% test by applying lugs on TSE certified cable connections with the assurance of Bemis controlled production*

*Purpose: The need for such products has increased due to the increase in technical man hour wages. It has been added to our list to meet this need.*



## Extension Cable Products

Product Code	Description	IP	Box	Pack
BKT-0102-8110	3x1,5 ttr 10mt Extension Cable Monophase IP68 Connector Socket	IP68	5	0
BKT-0118-8110	3x2,5 ttr 10mt Tribox Connector Cable IP68 sockets and plug	IP68	5	0
BKT-0506-2205	3x2,5 ttr 5mt Extension Cable Ceenorm 3/16A plug and Connector Socket	IP44	5	0
BKT-0506-2210	3x2,5 ttr 10mt Extension Cable Ceenorm 3/16A plug and Connector Socket	IP44	5	0
BKT-0708-2505	5x2,5 ttr 5mt Extension Cable Ceenorm 5/16A plug and Connector Socket	IP44	5	0
BKT-0708-2510	5x2,5 ttr 10mt Extension Cable Ceenorm 5/16A plug and Connector Socket	IP44	5	0
BX1K7444-2100	5x2,5 ttr 2mt Polybox Cable 5/16A plug	IP44	1	0
BX1K8222-2100	3x2,5 ttr 2mt Polybox Cable 3/16A plug	IP44	1	0

Product Code	Description	IP	Box	Pack
BKT-0502-2200	3x2,5 ttr 1,5mt Caravan Power Cable 3/16A - Rubber Connector Socket	IP44	10	0
BKT-0106-2200	3x2,5 ttr 1,5mt Caravan Power Cable 3/16A Connector Socket Rubber Monophase Plug	IP44	10	0
BKT-0102-2103	3x1,5 ttr 3mt Extension Cable Monophase Rubber Plug Monophase Rubber Connector Socket	IP44	10	0
BKT-0102-2105	3x1,5 ttr 5mt Extension Cable Monophase Rubber Plug Monophase Rubber Connector Socket	IP44	10	0
BKT-0102-2110	3x1,5 ttr 10mt Extension Cable Monophase Rubber Plug Monophase Rubber Connector Socket	IP44	5	0
BKT-0118-2103	3x1,5 ttr 3mt Extension Cable Triple Socket IP54	IP44	5	0
BKT-0118-2105	3x1,5 ttr 5mt Extension Cable Triple Socket IP54	IP44	5	0
BKT-0118-2110	3x1,5 ttr 10mt Extension Cable Triple Socket IP54	IP44	5	0



BKT-0502-2200    BKT-0106-2200    BKT-0102-2103    BKT-0102-2105    BKT-0102-2110    BKT-0118-2103



BKT-0118-2105    BKT-0118-2110    BKT-0102-8110    BKT-0118-8110    BKT-0506-2205    BKT-0506-2210



BKT-0708-2505    BKT-0708-2510    BX1K7444-2100    BX1K8222-2100

Bemis products are preferred due to their ease of assembly. All 90° Angled Surface with Monophase Panel Socket  
Our sockets have been wired and assembled to the terminal, this application is 16A. / 32A. / 63A. / 125A. / 160A.  
It is applied to all of our wall sockets.

IP44

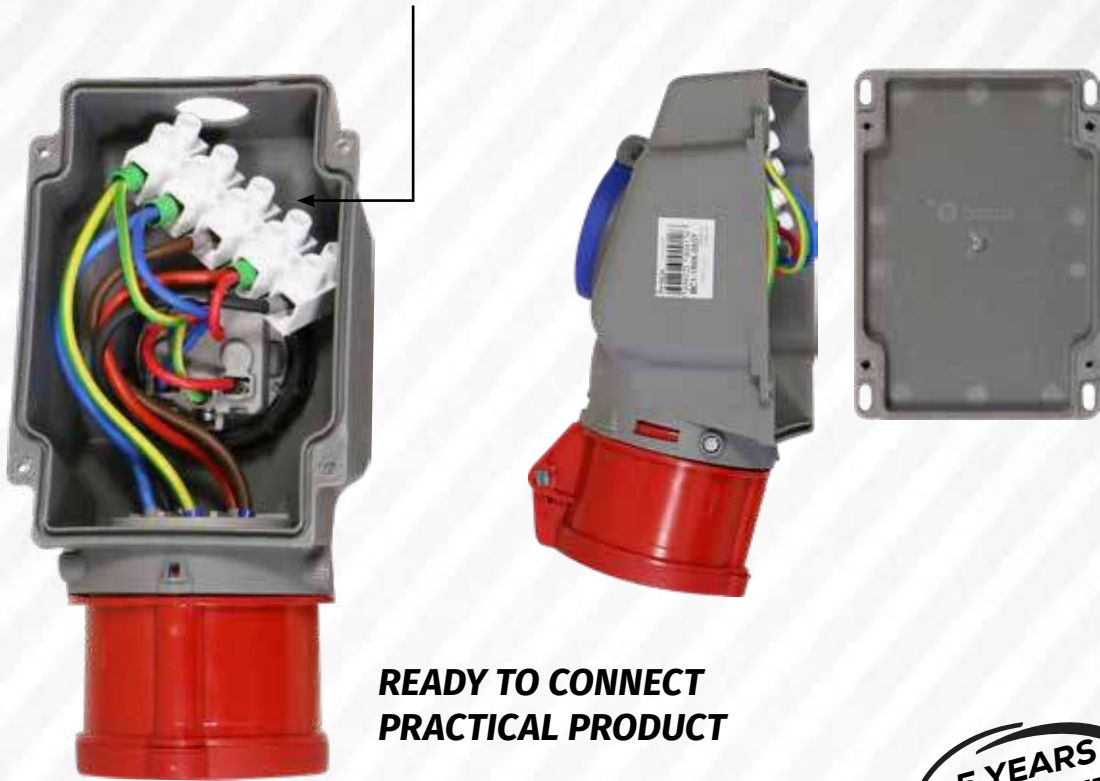

**READY TO CONNECT  
PRACTICAL PRODUCT**

**5 YEARS  
WARRANTY**

IP67

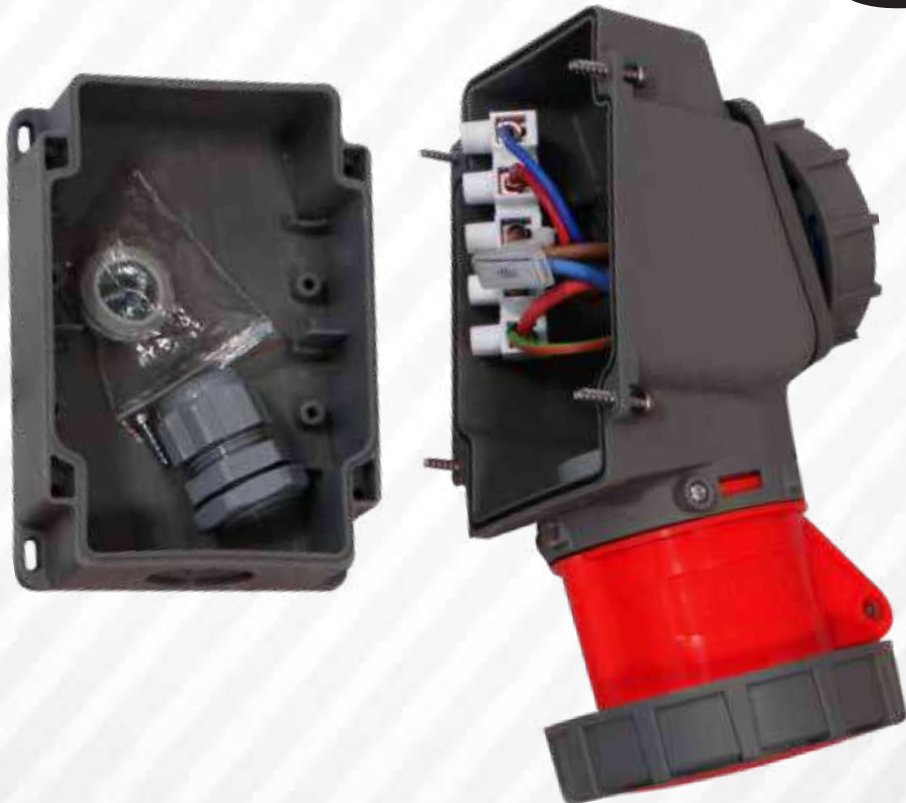



**5 YEAR  
WARRANTY**

### CEE Norm Plug & Socket Series

16A - 32A - 63A - 125A - 160A





**16A - 32A**

*CEE Norm Plug & Socket Series*



**CEE NORM**  
**5/32A. (3P+E+N) 380/450V~**



Fixing gland suitable for  
Ø8-18.5 cable

Cover design suitable for  
protection class

Possibility to hold the protective  
cover open with one hand

850°C heat resistant  
contact carrier

Stainless lock  
mechanism

High conductivity  
MS58 contact

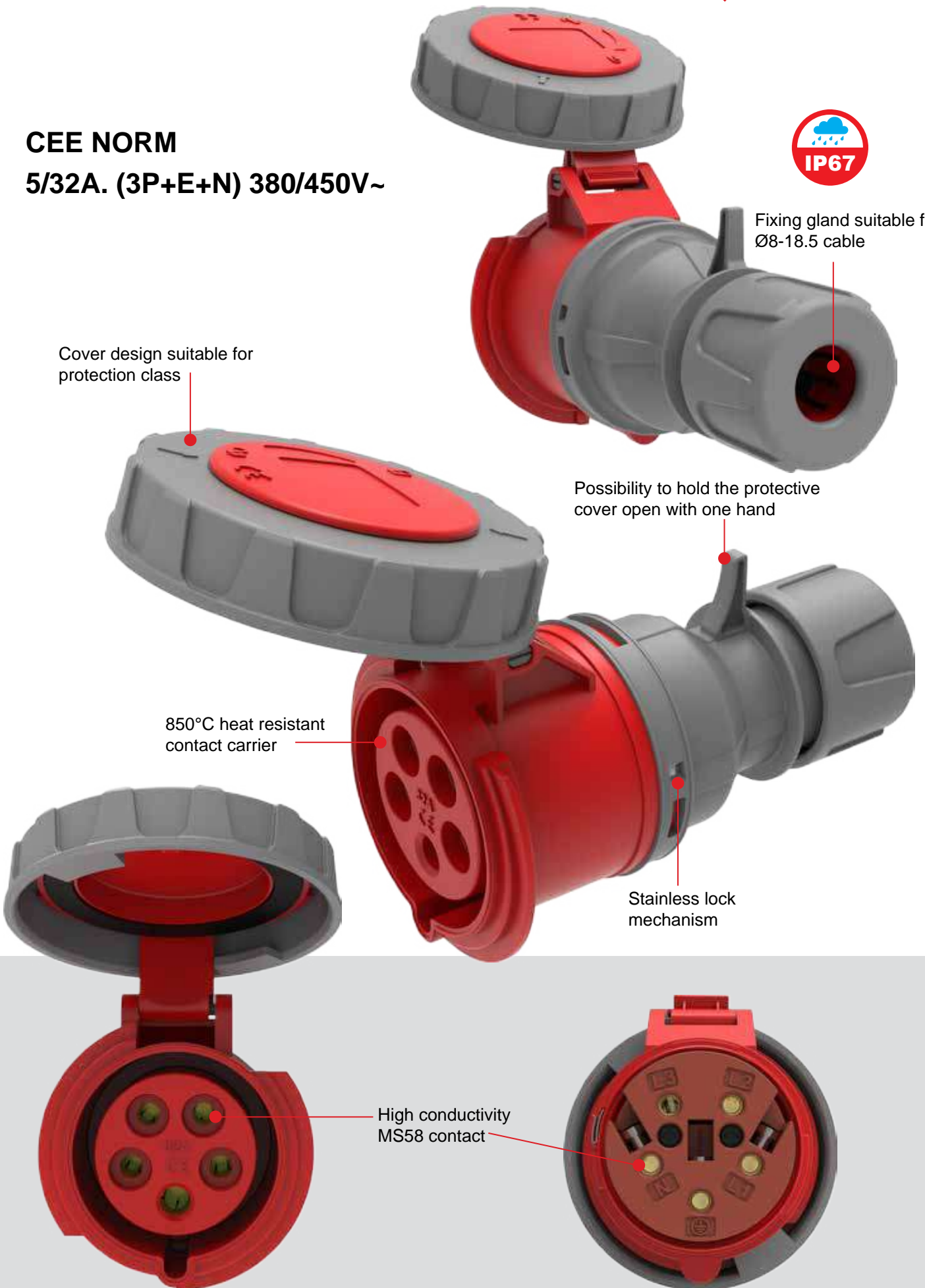



Product Code	Descriptions	IP	Box	Pack
BC1-1303-2011	3/16A. Straight Plug	IP44	10	120
BC1-1303-2312	3/16A. Connector Socket	IP44	10	120
BC1-1303-2413	3/16A. Panel Mounted Socket	IP44	15	120
BC1-1303-2114	3/16A. Panel Mounted Plug	IP44	10	120
BC1-1303-2130	3/16A. 90° Angled Rotate Plug	IP44	6	72
BC1-1303-2210	3/16A. Surface Mounted Plug	IP44	6	72
BC1-1303-2236	3/16A. 90° Angled Surface Plug	IP44	6	48
BC1-1303-2235	3/16A. 90° Angled Surface Plug with Cover	IP44	6	48
BC1-1303-2420	3/16A. 45° Angled Panel Mounted Socket	IP44	8	96
BC1-1303-2510	3/16A. Surface Mounted Socket	IP44	6	72
BC1-1303-2535	3/16A. 90° Angled Surface Socket	IP44	3	36

Product Code	Descriptions	IP	Box	Pack
BC1-1303-7011	3/16A. Straight Plug	IP67	8	96
BC1-1303-7312	3/16A. Connector Socket	IP67	8	96
BC1-1303-7413	3/16A. Panel Mounted Socket	IP67	8	96
BC1-1303-7114	3/16A. Panel Mounted Plug	IP67	10	120
BC1-1303-7210	3/16A. Surface Mounted Plug	IP67	4	48
BC1-1303-7236	3/16A. 90° Angled Surface Plug	IP67	3	36
BC1-1303-7420	3/16A. 45° Angled Panel Mounted Socket	IP67	6	72
BC1-1303-7510	3/16A. Surface Mounted Socket	IP67	4	48
BC1-1303-7535	3/16A. 90° Angled Surface Socket	IP67	3	36



### 3 Contact CEE Norm Series



**3/16A. (2P+E)**  
220V. 50/60 Hz. 6h  
(Polyamid 6)



Product Code	Descriptions	IP	Box	Pack
BC1-1403-2011	3/16A. Straight Plug	IP44	10	120
BC1-1403-2312	3/16A. Connector Socket	IP44	10	120
BC1-1403-2413	3/16A. Panel Mounted Socket	IP44	15	120
BC1-1403-2114	3/16A. Panel Mounted Plug	IP44	10	120
BC1-1403-2130	3/16A. 90° Angled Rotate Plug	IP44	6	72
BC1-1403-2210	3/16A. Surface Mounted Plug	IP44	6	72
BC1-1403-2236	3/16A. 90° Angled Surface Plug	IP44	6	48
BC1-1403-2235	3/16A. 90° Angled Surface Plug with Cover	IP44	6	48
BC1-1403-2535	3/16A. 90° Angled Surface Socket	IP44	3	36
BC1-1403-2420	3/16A. 45° Angled Panel Mounted Socket	IP44	8	96
BC1-1403-2510	3/16A. Surface Mounted Socket	IP44	6	72



Product Code	Descriptions	IP	Box	Pack
BC1-1403-7011	3/16A. Straight Plug	IP67	8	96
BC1-1403-7312	3/16A. Connector Socket	IP67	8	96
BC1-1403-7413	3/16A. Panel Mounted Socket	IP67	8	96
BC1-1403-7114	3/16A. Panel Mounted Plug	IP67	10	120
BC1-1403-7210	3/16A. Surface Mounted Plug	IP67	4	48
BC1-1403-7236	3/16A. 90° Angled Surface Plug	IP67	3	36
BC1-1403-7420	3/16A. 45° Angled Panel Mounted Socket	IP67	6	72
BC1-1403-7510	3/16A. Surface Mounted Socket	IP67	4	48
BC1-1403-7535	3/16A. 90° Angled Surface Socket	IP67	3	36



CEE Norm



Product Code	Descriptions	IP	Box	Pack
BC1-1504-2011	4/16A. Straight Plug	IP44	8	96
BC1-1504-2312	4/16A. Connector Socket	IP44	8	96
BC1-1504-2413	4/16A. Panel Mounted Socket	IP44	15	120
BC1-1504-2114	4/16A. Panel Mounted Plug	IP44	10	120
BC1-1504-2130	4/16A. 90° Angled Rotate Plug	IP44	6	72
BC1-1504-2210	4/16A. Surface Mounted Plug	IP44	6	72
BC1-1504-2235	4/16A. 90° Angled Surface Plug with Cover	IP44	6	48
BC1-1504-2236	4/16A. 90° Angled Surface Plug	IP44	6	48
BC1-1504-2420	4/16A. 45° Angled Panel Mounted Socket	IP44	8	96
BC1-1504-2510	4/16A. Surface Mounted Socket	IP44	6	72
BC1-1504-2535	4/16A. 90° Angled Surface Socket	IP44	3	36
BR1-1504-2711	4/16A. Rail Socket	IP20	6	72

Product Code	Descriptions	IP	Box	Pack
BC1-1504-7011	4/16A. Straight Plug	IP67	6	72
BC1-1504-7312	4/16A. Connector Socket	IP67	6	72
BC1-1504-7114	4/16A. Panel Mounted Plug	IP67	10	120
BC1-1504-7210	4/16A. Surface Mounted Plug	IP67	4	48
BC1-1504-7236	4/16A. 90° Angled Surface Plug	IP67	3	36
BC1-1504-7413	4/16A. Panel Mounted Socket	IP67	6	72
BC1-1504-7420	4/16A. 45° Angled Panel Mounted Socket	IP67	6	72
BC1-1504-7510	4/16A. Surface Mounted Socket	IP67	4	48
BC1-1504-7535	4/16A. 90° Angled Surface Socket	IP67	3	36





## 5 Contact CEE Norm Series



### 5/16A. (3P+E+N)

380V. 50/60 Hz. 6h  
(Polyamid 6)



Product Code	Descriptions	IP	Box	Pack
BC1-1505-2011	5/16A. Straight Plug	IP44	8	96
BC1-1505-2312	5/16A. Connector Socket	IP44	8	96
BC1-1505-2413	5/16A. Panel Mounted Socket (75x75)	IP44	15	120
BC1-1505-2114	5/16A. Panel Mounted Plug	IP44	8	96
BC1-1505-2140	5/16A. Screwless Connection Plug	IP44	8	64
BC1-1505-2130	5/16A. 90° Angled Rotate Plug	IP44	6	72
BC1-1505-2210	5/16A. Surface Mounted Plug	IP44	6	72
BC1-1505-2236	5/16A. 90° Angled Surface Plug	IP44	3	36
BC1-1505-2235	5/16A. 90° Angled Surface Plug with Cover	IP44	3	36
BC1-1505-2238	5/16A. 90° Angled Surface Plug with Schuko	IP44	3	24
BC1-1505-2240	5/16A. Pako Switch 90° Angled Surface Plug	IP44	1	12
BC1-1505-2420	5/16A. 45° Angled Panel Mounted Socket	IP44	6	72
BC1-1505-2440	5/16A. Screwless Connection Socket	IP44	8	64
BC1-1505-2510	5/16A. Surface Mounted Socket	IP44	6	72
BC1-1505-2535	5/16A. 90° Angled Surface Socket	IP44	3	36
BC1-1505-2537	5/16A. 90° Angled Surface Socket with Schuko	IP44	3	24
BC1-1505-2550	5/16A. 90° Angled Surface Socket with Pako Switch	IP44	1	12
BC1-1505-2050	5/16A. Inverter Straight Plug	IP44	8	64
BC1-1505-2070	5/16A. Inverter Panel Mounted Plug	IP44	8	96
BC1-1505-2080	5/16A. 90° Angled Inverter Rotate Plug	IP44	6	72
BC1-1505-2060	5/16A. 90° Angled Inverter Surface Plug	IP44	3	36
BC1-1505-2061	5/16A. 90° Angled Inverter Surface Plug with Cover	IP44	3	36
BR1-1505-2711	5/16A. Rail Socket	IP20	6	72



Product Code	Descriptions	IP	Box	Pack
BC1-1505-7011	5/16A. Straight Plug	IP67	4	48
BC1-1505-7312	5/16A. Connector Socket	IP67	4	48
BC1-1505-7413	5/16A. Panel Mounted Socket (75x75)	IP67	6	72
BC1-1505-7114	5/16A. Panel Mounted Plug (83x90)	IP67	6	72
BC1-1505-7210	5/16A. Surface Mounted Plug	IP67	4	48
BC1-1505-7236	5/16A. 90° Angled Surface Plug	IP67	3	36
BC1-1505-7238	5/16A. 90° Angled Surface Plug with Schuko	IP67	1	12
BC1-1505-7420	5/16A. 45° Angled Panel Mounted Socket	IP67	6	72
BC1-1505-7440	5/16A. Screwless Connection Socket	IP67	6	72
BC1-1505-7510	5/16A. Surface Mounted Socket	IP67	4	48
BC1-1505-7535	5/16A. 90° Angled Surface Socket	IP67	3	36
BC1-1505-7537	5/16A. 90° Angled Surface Socket with Schuko	IP67	1	12
BC1-1505-7050	5/16A. Inverter Straight Plug	IP67	4	48
BC1-1505-7060	5/16A. Inverter Panel Mounted Plug	IP67	3	36
BC1-1505-7070	5/16A. 90° Angled Inverter Surface Plug	IP67	6	72

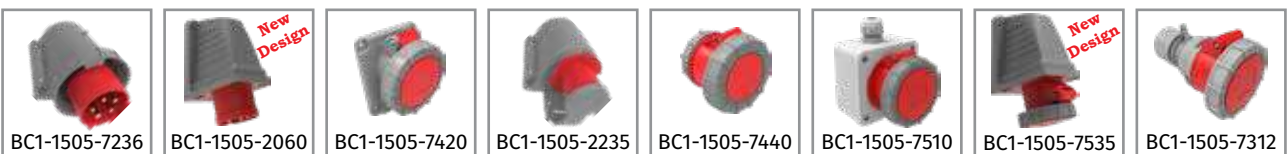

CEE Norm



Product Code	Descriptions	IP	Box	Pack
BC1-3303-2011	3/32A. Straight Plug	IP44	8	64
BC1-3303-2312	3/32A. Connector Socket	IP44	8	64
BC1-3303-2413	3/32A. Panel Mounted Socket (75x75)	IP44	8	64
BC1-3303-2114	3/32A. Panel Mounted Plug	IP44	8	96
BC1-3303-2140	3/32A. Screwless Connection Plug	IP44	8	64
BC1-3303-2130	3/32A. 90° Angled Rotate Plug	IP44	6	72
BC1-3303-2210	3/32A. Surface Mounted Plug	IP44	6	72
BC1-3303-2236	3/32A. 90° Angled Surface Plug	IP44	3	36
BC1-3303-2235	3/32A. 90° Angled Surface Plug with Cover	IP44	3	36
BC1-3303-2238	3/32A. 90° Angled Surface Plug with Schuko	IP44	3	24
BC1-3303-2240	3/32A. Pako Switch 90° Angled Surface Plug	IP44	1	12
BC1-3303-2440	3/32A. Screwless Connection Socket	IP44	8	64
BC1-3303-2510	3/32A. Surface Mounted Socket	IP44	6	72
BC1-3303-2535	3/32A. 90° Angled Surface Socket	IP44	3	36
BC1-3303-2537	3/32A. 90° Angled Surface Socket with Schuko	IP44	3	24
BC1-3303-2550	3/32A. 90° Angled Surface Socket with Pako Switch	IP44	1	12

Product Code	Descriptions	IP	Box	Pack
BC1-3303-7011	3/32A. Straight Plug	IP67	3	36
BC1-3303-7312	3/32A. Connector Socket	IP67	3	36
BC1-3303-7413	3/32A. Panel Mounted Socket (75x75)	IP67	4	48
BC1-3303-7114	3/32A. Panel Mounted Plug (83x90)	IP67	6	72
BC1-3303-7210	3/32A. Surface Mounted Plug	IP67	2	16
BC1-3303-7236	3/32A. 90° Angled Surface Plug	IP67	3	36
BC1-3303-7238	3/32A. 90° Angled Surface Plug with Schuko	IP67	1	12
BC1-3303-7440	3/32A. Screwless Connection Socket	IP67	4	48
BC1-3303-7510	3/32A. Surface Mounted Socket	IP67	2	24
BC1-3303-7535	3/32A. 90° Angled Surface Socket	IP67	3	36
BC1-3303-7537	3/32A. 90° Angled Surface Socket with Schuko	IP67	1	12



# 3 Contact CEE Norm Series



**3/32A. (2P+E)**  
 220V. 50/60 Hz. 6h  
 (Polyamid 6)



Product Code	Descriptions	IP	Box	Pack
BC1-3403-2011	3/32A. Straight Plug	IP44	8	64
BC1-3403-2312	3/32A. Connector Socket	IP44	8	64
BC1-3403-2413	3/32A. Panel Mounted Socket (75x75)	IP44	8	64
BC1-3403-2114	3/32A. Panel Mounted Plug	IP44	8	96
BC1-3403-2140	3/32A. Screwless Connection Plug	IP44	8	64
BC1-3403-2130	3/32A. 90° Angled Rotate Plug	IP44	6	72
BC1-3403-2210	3/32A. Surface Mounted Plug	IP44	6	72
BC1-3403-2236	3/32A. 90° Angled Surface Plug	IP44	3	36
BC1-3403-2235	3/32A. 90° Angled Surface Plug with Cover	IP44	3	36
BC1-3403-2238	3/32A. 90° Angled Surface Plug with Schuko	IP44	3	24
BC1-3403-2240	3/32A. Pako Switch 90° Angled Surface Plug	IP44	1	12
BC1-3403-2420	3/32A. 45° Angled Panel Mounted Socket	IP44	4	48
BC1-3403-2440	3/32A. Screwless Connection Socket	IP44	8	64
BC1-3403-2510	3/32A. Surface Mounted Socket	IP44	6	72
BC1-3403-2535	3/32A. 90° Angled Surface Socket	IP44	3	36
BC1-3403-2537	3/32A. 90° Angled Surface Socket with Schuko	IP44	3	24
BC1-3403-2550	3/32A. 90° Angled Surface Socket with Pako Switch	IP44	1	12



Product Code	Descriptions	IP	Box	Pack
BC1-3403-7011	3/32A. Straight Plug	IP67	3	36
BC1-3403-7312	3/32A. Connector Socket	IP67	3	36
BC1-3403-7413	3/32A. Panel Mounted Socket (75x75)	IP67	4	48
BC1-3403-7114	3/32A. Panel Mounted Plug (83x90)	IP67	6	72
BC1-3403-7210	3/32A. Surface Mounted Plug	IP67	2	16
BC1-3403-7236	3/32A. 90° Angled Surface Plug	IP67	3	36
BC1-3403-7238	3/32A. 90° Angled Surface Plug with Schuko	IP67	1	12
BC1-3403-7420	3/32A. 45° Angled Panel Mounted Socket	IP67	4	48
BC1-3403-7440	3/32A. Screwless Connection Socket	IP67	4	48
BC1-3403-7510	3/32A. Surface Mounted Socket	IP67	2	24
BC1-3403-7535	3/32A. 90° Angled Surface Socket	IP67	3	36
BC1-3403-7537	3/32A. 90° Angled Surface Socket with Schuko	IP67	1	12





BC1-3504-2011

BC1-3504-2312



BC1-3504-2114

BC1-3504-2413

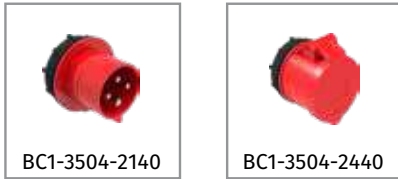

BC1-3504-2140

BC1-3504-2440

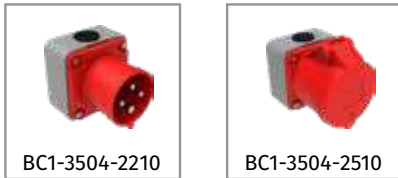

BC1-3504-2210

BC1-3504-2510



BC1-3504-2130

BC1-3504-2235



BC1-3504-2240

BC1-3504-2550

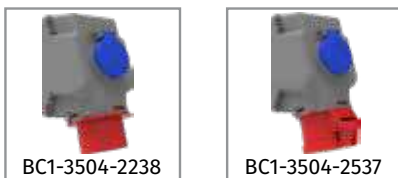

BC1-3504-2238

BC1-3504-2537



BC1-3504-2236

BC1-3504-2535

Product Code	Descriptions	IP	Box	Pack
BC1-3504-2011	4/32A. Straight Plug	IP44	8	64
BC1-3504-2312	4/32A. Connector Socket	IP44	8	64
BC1-3504-2413	4/32A. Panel Mounted Socket (75x75)	IP44	8	64
BC1-3504-2114	4/32A. Panel Mounted Plug	IP44	8	96
BC1-3504-2140	4/32A. Screwless Connection Plug	IP44	8	64
BC1-3504-2130	4/32A. 90° Angled Rotate Plug	IP44	6	72
BC1-3504-2210	4/32A. Surface Mounted Plug	IP44	6	72
BC1-3504-2236	4/32A. 90° Angled Surface Plug	IP44	3	36
BC1-3504-2235	4/32A. 90° Angled Surface Plug with Cover	IP44	3	36
BC1-3504-2238	4/32A. 90° Angled Surface Plug with Schuko	IP44	3	24
BC1-3504-2240	4/32A. Pako Switch 90° Angled Surface Plug	IP44	1	12
BC1-3504-2420	4/32A. 45° Angled Panel Mounted Socket	IP44	4	48
BC1-3504-2440	4/32A. Screwless Connection Socket	IP44	8	64
BC1-3504-2510	4/32A. Surface Mounted Socket	IP44	6	72
BC1-3504-2535	4/32A. 90° Angled Surface Socket	IP44	3	36
BC1-3504-2537	4/32A. 90° Angled Surface Socket with Schuko	IP44	3	24
BC1-3504-2550	4/32A. 90° Angled Surface Socket with Pako Switch	IP44	1	12

Product Code	Descriptions	IP	Box	Pack
BC1-3504-7011	4/32A. Straight Plug	IP67	3	36
BC1-3504-7312	4/32A. Connector Socket	IP67	3	36
BC1-3504-7413	4/32A. Panel Mounted Socket (75x75)	IP67	4	48
BC1-3504-7114	4/32A. Panel Mounted Plug (83x90)	IP67	6	72
BC1-3504-7210	4/32A. Surface Mounted Plug	IP67	2	16
BC1-3504-7236	4/32A. 90° Angled Surface Plug	IP67	3	36
BC1-3504-7238	4/32A. 90° Angled Surface Plug with Schuko	IP67	1	12
BC1-3504-7420	4/32A. 45° Angled Panel Mounted Socket	IP67	4	48
BC1-3504-7440	4/32A. Screwless Connection Socket	IP67	4	48
BC1-3504-7510	4/32A. Surface Mounted Socket	IP67	2	24
BC1-3504-7535	4/32A. 90° Angled Surface Socket	IP67	3	36
BC1-3504-7537	4/32A. 90° Angled Surface Socket with Schuko	IP67	1	12

3h CEE Norm series can be produced optionally



BC1-3504-7114

BC1-3504-7238

BC1-3504-7210

BC1-3504-7236



BC1-3504-7011

BC1-3504-7312

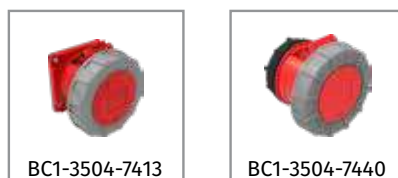

BC1-3504-7413

BC1-3504-7440



BC1-3504-7510



BC1-3504-7535

## 5 Contact CEE Norm Series



**5/32A. (3P+E+N)**  
380V. 50/60 Hz. 6h  
(Polyamid 6)



Product Code	Descriptions	IP	Box	Pack
BC1-3505-2011	5/32A. Straight Plug	IP44	8	64
BC1-3505-2312	5/32A. Connector Socket	IP44	8	64
BC1-3505-2413	5/32A. Panel Mounted Socket (75x75)	IP44	8	64
BC1-3505-2114	5/32A. Panel Mounted Plug	IP44	8	96
BC1-3505-2140	5/32A. Screwless Connection Plug	IP44	8	64
BC1-3505-2130	5/32A. 90° Angled Rotate Plug	IP44	6	72
BC1-3505-2210	5/32A. Surface Mounted Plug	IP44	6	72
BC1-3505-2236	5/32A. 90° Angled Surface Plug	IP44	3	36
BC1-3505-2235	5/32A. 90° Angled Surface Plug with Cover	IP44	3	36
BC1-3505-2238	5/32A. 90° Angled Surface Plug with Schuko	IP44	3	24
BC1-3505-2240	5/32A. Pako Switch 90° Angled Surface Plug	IP44	1	12
BC1-3505-2420	5/32A. 45° Angled Panel Mounted Socket	IP44	6	72
BC1-3505-2440	5/32A. Screwless Connection Socket	IP44	8	64
BC1-3505-2510	5/32A. Surface Mounted Socket	IP44	6	72
BC1-3505-2535	5/32A. 90° Angled Surface Socket	IP44	3	36
BC1-3505-2537	5/32A. 90° Angled Surface Socket with Schuko	IP44	3	24
BC1-3505-2550	5/32A. 90° Angled Surface Socket with Pako Switch	IP44	1	12
BC1-3505-2050	5/32A. Inverter Straight Plug	IP44	8	64
BC1-3505-2060	5/32A. Inverter Panel Mounted Plug	IP44	3	36
BC1-3505-2061	5/32A. 90° Angled Inverter Rotate Plug	IP44	3	36
BC1-3505-2070	5/32A. 90° Angled Inverter Surface Plug	IP44	8	96
BC1-3505-2080	5/32A. 90° Angled Inverter Surface Plug with Cover	IP44	6	72



Product Code	Descriptions	IP	Box	Pack
BC1-3505-7011	5/32A. Straight Plug	IP67	3	36
BC1-3505-7312	5/32A. Connector Socket	IP67	3	36
BC1-3505-7413	5/32A. Panel Mounted Socket (75x75)	IP67	4	48
BC1-3505-7114	5/32A. Panel Mounted Plug (83x90)	IP67	6	72
BC1-3505-7210	5/32A. Surface Mounted Plug	IP67	2	16
BC1-3505-7236	5/32A. 90° Angled Surface Plug	IP67	3	36
BC1-3505-7238	5/32A. 90° Angled Surface Plug with Schuko	IP67	1	12
BC1-3505-7420	5/32A. 45° Angled Panel Mounted Socket	IP67	4	48
BC1-3505-7440	5/32A. Screwless Connection Socket	IP67	4	48
BC1-3505-7510	5/32A. Surface Mounted Socket	IP67	2	24
BC1-3505-7535	5/32A. 90° Angled Surface Socket	IP67	3	36
BC1-3505-7537	5/32A. 90° Angled Surface Socket with Schuko	IP67	1	12
BC1-3505-7050	5/32A. Inverter Straight Plug	IP67	3	36
BC1-3505-7060	5/32A. Inverter Panel Mounted Plug	IP67	3	36
BC1-3505-7070	5/32A. 90° Angled Inverter Surface Plug	IP67	6	72



**B** bemis



**63A - 125A - 160A**

*CEE Norm RS Series Plug & Socket*

**RS**

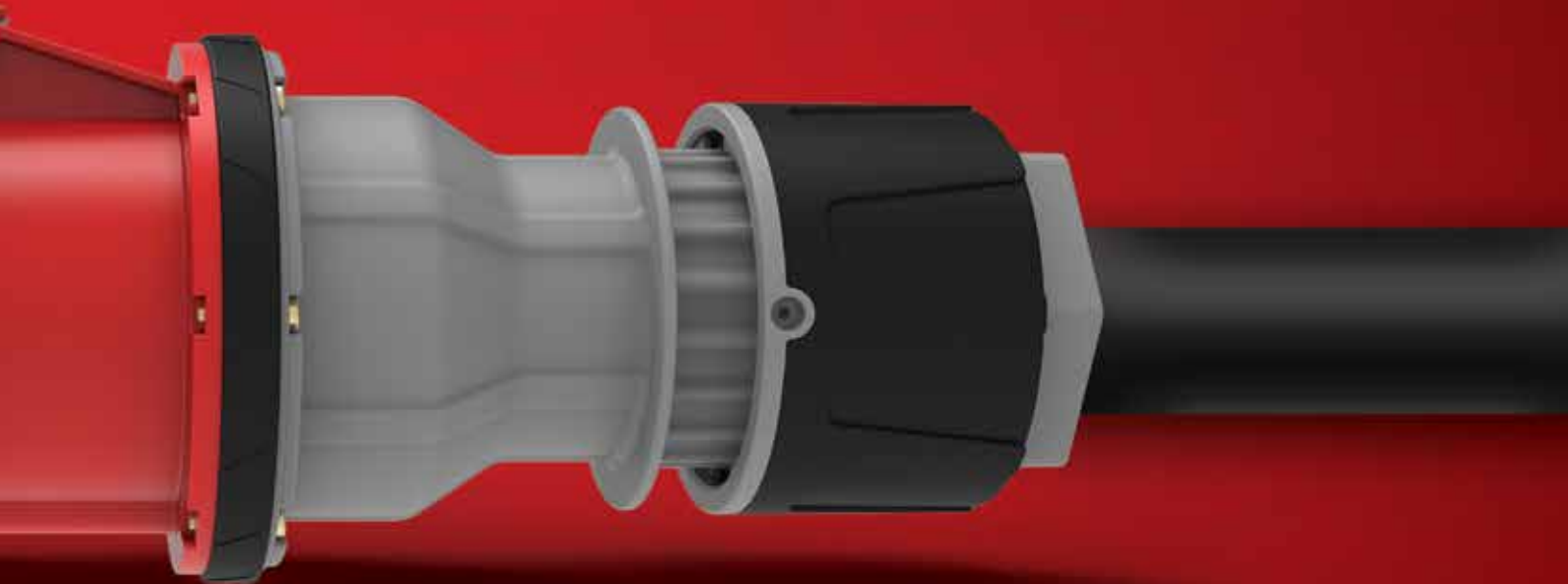



Product Code	Descriptions	IP	Box	Pack
BC1-4303-2011	3/63A. Straight Plug	IP44	1	12
BC1-4303-2312	3/63A. Connector Socket	IP44	1	12
BC1-4303-2413	3/63A. Panel Mounted Socket	IP44	1	24
BC1-4303-2114	3/63A. Panel Mounted Plug	IP44	1	24
BC1-4303-2420	3/63A. 45° Angled Panel Mounted Socket	IP44	1	24
BC1-4303-2510	3/63A. Surface Mounted Socket	IP44	1	8
BC1-4303-2535	3/63A. 90° Angled Surface Socket	IP44	1	7
BC1-4303-2537	3/63A. 90° Angled Surface Socket with Schuko	IP44	1	7
BC1-4303-2210	3/63A. Surface Mounted Plug	IP44	1	8
BC1-4303-2236	3/63A. 90° Angled Surface Plug	IP44	1	7
BC1-4303-2238	3/63A. 90° Angled Surface Plug with Schuko	IP44	1	7
BC1-4303-2240	3/63A. 90° Angled Pako Switchli Surface Mounted Plug	IP44	1	7
BC1-4303-2550	3/63A. 90° Angled Pako Switchli Surface Mounted Socket	IP44	1	7

Product Code	Descriptions	IP	Box	Pack
BC1-4303-7011	3/63A. Straight Plug	IP67	1	12
BC1-4303-7312	3/63A. Connector Socket	IP67	1	12
BC1-4303-7413	3/63A. Panel Mounted Socket	IP67	1	24
BC1-4303-7114	3/63A. Panel Mounted Plug	IP67	1	24
BC1-4303-7420	3/63A. 45° Angled Panel Mounted Socket	IP67	1	24
BC1-4303-7510	3/63A. Surface Mounted Socket	IP67	1	8
BC1-4303-7535	3/63A. 90° Angled Surface Socket	IP67	1	7
BC1-4303-7537	3/63A. 90° Angled Surface Socket with Schuko	IP67	1	7
BC1-4303-7210	3/63A. Surface Mounted Plug	IP67	1	8
BC1-4303-7236	3/63A. 90° Angled Surface Plug	IP67	1	7
BC1-4303-7238	3/63A. 90° Angled Surface Plug with Schuko	IP67	1	7
BC1-4303-7240	3/63A. 90° Angled Pako Switchli Surface Mounted Plug	IP65	1	7
BC1-4303-7550	3/63A. 90° Angled Pako Switchli Surface Mounted Socket	IP65	1	7





## 3 Contact CEE Norm Series



**3/63A. (2P+E)**  
220V. 50/60 Hz. 6h  
(Polyamid 6)



Product Code	Descriptions	IP	Box	Pack
BC1-4403-2011	3/63A. Straight Plug	IP44	1	12
BC1-4403-2312	3/63A. Connector Socket	IP44	1	12
BC1-4403-2413	3/63A. Panel Mounted Socket	IP44	1	24
BC1-4403-2114	3/63A. Panel Mounted Plug	IP44	1	24
BC1-4403-2420	3/63A. 45° Angled Panel Mounted Socket	IP44	1	24
BC1-4403-2510	3/63A. Surface Mounted Socket	IP44	1	8
BC1-4403-2535	3/63A. 90° Angled Surface Socket	IP44	1	7
BC1-4403-2537	3/63A. 90° Angled Surface Socket with Schuko	IP44	1	7
BC1-4403-2210	3/63A. Surface Mounted Plug	IP44	1	8
BC1-4403-2236	3/63A. 90° Angled Surface Plug	IP44	1	7
BC1-4403-2238	3/63A. 90° Angled Surface Plug with Schuko	IP44	1	7
BC1-4403-2240	3/63A. 90° Angled Pako Switchli Surface Mounted Plug	IP44	1	7
BC1-4403-2550	3/63A. 90° Angled Pako Switchli Surface Mounted Socket	IP44	1	7



BC1-4403-2011



BC1-4403-2312



BC1-4403-2413



BC1-4403-2114

Product Code	Descriptions	IP	Box	Pack
BC1-4403-7011	3/63A. Straight Plug	IP67	1	12
BC1-4403-7312	3/63A. Connector Socket	IP67	1	12
BC1-4403-7413	3/63A. Panel Mounted Socket	IP67	1	24
BC1-4403-7114	3/63A. Panel Mounted Plug	IP67	1	24
BC1-4403-7420	3/63A. 45° Angled Panel Mounted Socket	IP67	1	24
BC1-4403-7510	3/63A. Surface Mounted Socket	IP67	1	8
BC1-4403-7535	3/63A. 90° Angled Surface Socket	IP67	1	7
BC1-4403-7537	3/63A. 90° Angled Surface Socket with Schuko	IP67	1	7
BC1-4403-7210	3/63A. Surface Mounted Plug	IP67	1	8
BC1-4403-7236	3/63A. 90° Angled Surface Plug	IP67	1	7
BC1-4403-7238	3/63A. 90° Angled Surface Plug with Schuko	IP67	1	7
BC1-4403-7240	3/63A. 90° Angled Pako Switchli Surface Mounted Plug	IP65	1	7
BC1-4403-7550	3/63A. 90° Angled Pako Switchli Surface Mounted Socket	IP65	1	7



BC1-4403-2420



BC1-4403-2535



BC1-4403-2537



BC1-4403-2238



BC1-4403-2240



BC1-4403-7011



BC1-4403-7312



BC1-4403-7114



BC1-4403-7413



BC1-4403-7420



BC1-4403-2550



BC1-4403-7236



BC1-4403-7535



BC1-4403-7537



BC1-4403-7550



BC1-4403-7240

# RS SERIES

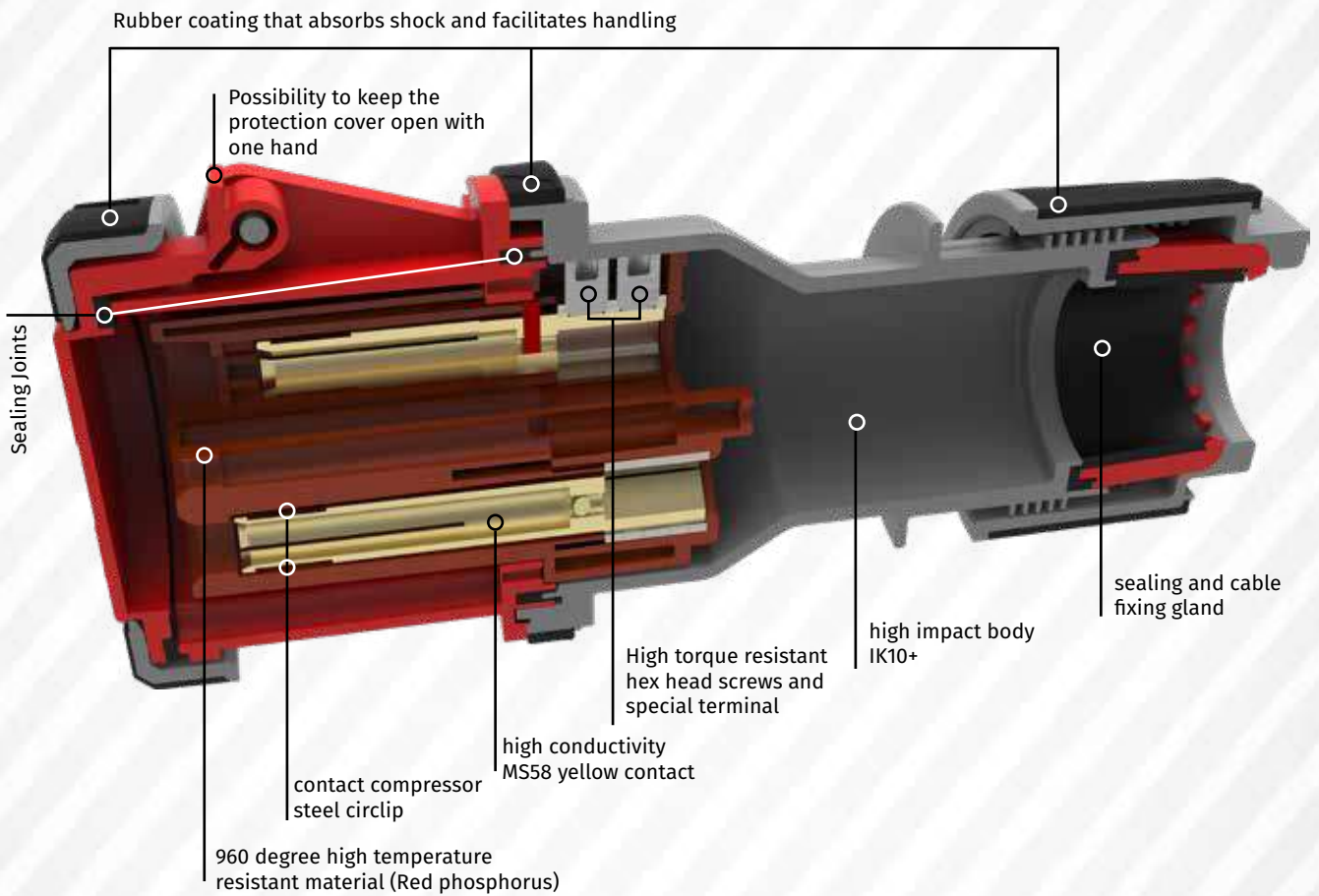

## IK10+



**4/63A. (3P+E)**  
380V. 50/60 Hz. 6h  
(Polyamid 6)

**4 Contact CEE Norm Series**



Product Code	Descriptions	IP	Box	Pack
BC1-4504-2011	4/63A. Straight Plug	IP44	1	12
BC1-4504-2312	4/63A. Connector Socket	IP44	1	12
BC1-4504-2413	4/63A. Panel Mounted Socket	IP44	1	24
BC1-4504-2114	4/63A. Panel Mounted Plug	IP44	1	24
BC1-4504-2420	4/63A. 45° Angled Panel Mounted Socket	IP44	1	24
BC1-4504-2510	4/63A. Surface Mounted Socket	IP44	1	8
BC1-4504-2535	4/63A. 90° Angled Surface Socket	IP44	1	7
BC1-4504-2537	4/63A. 90° Angled Surface Socket with Schuko	IP44	1	7
BC1-4504-2210	4/63A. Surface Mounted Plug	IP44	1	8
BC1-4504-2236	4/63A. 90° Angled Surface Plug	IP44	1	7
BC1-4504-2238	4/63A. 90° Angled Surface Plug with Schuko	IP44	1	7



Product Code	Descriptions	IP	Box	Pack
BC1-4504-7011	4/63A. Straight Plug	IP67	1	12
BC1-4504-7312	4/63A. Connector Socket	IP67	1	12
BC1-4504-7413	4/63A. Panel Mounted Socket	IP67	1	24
BC1-4504-7114	4/63A. Panel Mounted Plug	IP67	1	24
BC1-4504-7420	4/63A. 45° Angled Panel Mounted Socket	IP67	1	24
BC1-4504-7510	4/63A. Surface Mounted Socket	IP67	1	8
BC1-4504-7535	4/63A. 90° Angled Surface Socket	IP67	1	7
BC1-4504-7537	4/63A. 90° Angled Surface Socket with Schuko	IP67	1	7
BC1-4504-7210	4/63A. Surface Mounted Plug	IP67	1	8
BC1-4504-7236	4/63A. 90° Angled Surface Plug	IP67	1	7
BC1-4504-7238	4/63A. 90° Angled Surface Plug with Schuko	IP67	1	7

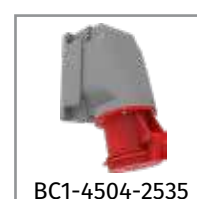

CEE Norm



**5/63A. (3P+E+N)**  
380V. 50/60 Hz. 6h  
(Polyamid 6)









Product Code	Descriptions	IP	Box	Pack
BC1-4505-2011	5/63A. Straight Plug	IP44	1	12
BC1-4505-2312	5/63A. Connector Socket	IP44	1	12
BC1-4505-2413	5/63A. Panel Mounted Socket	IP44	1	24
BC1-4505-2114	5/63A. Panel Mounted Plug	IP44	1	24
BC1-4505-2420	5/63A. 45° Angled Panel Mounted Socket	IP44	1	24
BC1-4505-2510	5/63A. Surface Mounted Socket	IP44	1	8
BC1-4505-2535	5/63A. 90° Angled Surface Socket	IP44	1	7
BC1-4505-2537	5/63A. 90° Angled Surface Socket with Schuko	IP44	1	7
BC1-4505-2210	5/63A. Surface Mounted Plug	IP44	1	8
BC1-4505-2236	5/63A. 90° Angled Surface Plug	IP44	1	7
BC1-4505-2238	5/63A. 90° Angled Surface Plug with Schuko	IP44	1	7

Product Code	Descriptions	IP	Box	Pack
BC1-4505-7011	5/63A. Straight Plug	IP67	1	12
BC1-4505-7312	5/63A. Connector Socket	IP67	1	12
BC1-4505-7413	5/63A. Panel Mounted Socket	IP67	1	24
BC1-4505-7114	5/63A. Panel Mounted Plug	IP67	1	24
BC1-4505-7420	5/63A. 45° Angled Panel Mounted Socket	IP67	1	24
BC1-4505-7510	5/63A. Surface Mounted Socket	IP67	1	8
BC1-4505-7535	5/63A. 90° Angled Surface Socket	IP67	1	7
BC1-4505-7537	5/63A. 90° Angled Surface Socket with Schuko	IP67	1	7
BC1-4505-7210	5/63A. Surface Mounted Plug	IP67	1	8
BC1-4505-7236	5/63A. 90° Angled Surface Plug	IP67	1	7
BC1-4505-7238	5/63A. 90° Angled Surface Plug with Schuko	IP67	1	7



**3/125A. (2P+E)**  
 220V. 50/60 Hz. 6h  
 (Polyamid 6)



Product Code	Description	IP	Box	Pack	
BC1-6403-7011	3/125A. Straight Plug	IP67	1	8	 BC1-6403-7011
BC1-6403-7312	3/125A. Connector Socket	IP67	1	8	 BC1-6403-7312
BC1-6403-7413	3/125A. Panel Mounted Socket	IP67	1	8	
BC1-6403-7114	3/125A. Panel Mounted Plug	IP67	1	8	 BC1-6403-7413
BC1-6403-7420	3/125A. 45° Angled Panel Mounted Socket	IP67	1	8	
BC1-6403-7236	3/125A. 90° Angled Surface Plug	IP67	1	4	 BC1-6403-7114
BC1-6403-7535	3/125A. 90° Angled Surface Socket	IP67	1	4	
BC1-6403-7238	3/125A. 90° Angled Surface Plug with Schuko	IP67	1	4	 BC1-6403-7238
BC1-6403-7537	3/125A. 90° Angled Surface Socket with Schuko	IP67	1	4	
BC1-6403-7240	3/125A. 90° Angled Surface Plug with Pako Switch	IP65	1	4	 BC1-6403-7240
BC1-6403-7550	3/125A. 90° Angled Surface Socket with Pako Switch	IP65	1	4	





**4/125A. (3P+E)**  
 380V. 50/60 Hz. 6h  
 (Polyamid 6)

	Product Code	Description	IP	Box	Pack
 BC1-6504-7011	BC1-6504-7011	4/125A. Straight Plug	IP67	1	8
 BC1-6504-7312	BC1-6504-7312	4/125A. Connector Socket	IP67	1	8
 BC1-6504-7413	BC1-6504-7413	4/125A. Panel Mounted Socket	IP67	1	8
 BC1-6504-7114	BC1-6504-7114	4/125A. Panel Mounted Plug	IP67	1	8
 BC1-6504-7420	BC1-6504-7420	4/125A. 45° Angled Panel Mounted Socket	IP67	1	8
 BC1-6504-7236	BC1-6504-7236	4/125A. 90° Angled Surface Plug	IP67	1	4
 BC1-6504-7535	BC1-6504-7535	4/125A. 90° Angled Surface Socket	IP67	1	4
 BC1-6504-7238	BC1-6504-7238	4/125A. 90° Angled Surface Plug with Schuko	IP67	1	4
 BC1-6504-7537	BC1-6504-7537	4/125A. 90° Angled Surface Socket with Schuko	IP67	1	4
 BC1-6504-7240	BC1-6504-7240	4/125A. 90° Angled Surface Plug with Pako Switch	IP65	1	4
 BC1-6504-7550	BC1-6504-7550	4/125A. 90° Angled Surface Socket with Pako Switch	IP65	1	4

**5/125A. (3P+E+N)**  
 380V. 50/60 Hz. 6h  
 (Polyamid 6)



Product Code	Description	IP	Box	Pack
BC1-6505-7011	5/125A. Straight Plug	IP67	1	8
BC1-6505-7312	5/125A. Connector Socket	IP67	1	8
BC1-6505-7413	5/125A. Panel Mounted Socket	IP67	1	8
BC1-6505-7114	5/125A. Panel Mounted Plug	IP67	1	8
BC1-6505-7420	5/125A. 45° Angled Panel Mounted Socket	IP67	1	8
BC1-6505-7236	5/125A. 90° Angled Surface Plug	IP67	1	4
BC1-6505-7535	5/125A. 90° Angled Surface Socket	IP67	1	4
BC1-6505-7238	5/125A. 90° Angled Surface Plug with Schuko	IP67	1	4
BC1-6505-7537	5/125A. 90° Angled Surface Socket with Schuko	IP67	1	4
BC1-6505-7240	5/125A. 90° Angled Surface Plug with Pako Switch	IP65	1	4
BC1-6505-7550	5/125A. 90° Angled Surface Socket with Pako Switch	IP65	1	4



# **FIRST TIME IN TURKEY**

## **CEE Norm 160A. 380V.**



Special Silver Plated Contacts



## 4/160A. (3P+E)

380V. 50/60 Hz. 7h  
(Polyamid 6)



Product Code	Descriptions	IP	Box	Pack
BC1-8504-7011	4/160A. Straight Plug	IP67	1	8
BC1-8504-7312	4/160A. Connector Socket	IP67	1	8
BC1-8504-7413	4/160A. Panel Mounted Socket	IP67	1	8
BC1-8504-7114	4/160A. Panel Mounted Plug	IP67	1	8
BC1-8504-7420	4/160A. 45° Angled Panel Mounted Socket	IP67	1	8
BC1-8504-7236	4/160A. 90° Angled Surface Plug	IP67	1	4
BC1-8504-7535	4/160A. 90° Angled Surface Socket	IP67	1	4
BC1-8504-7238	4/160A. 90° Angled Surface Plug with Schuko	IP67	1	4
BC1-8504-7537	4/160A. 90° Angled Surface Socket with Schuko	IP67	1	4
BC1-8504-7240	4/160A. 90° Angled Surface Plug with Pako Switch	IP65	1	4
BC1-8504-7550	4/160A. 90° Angled Surface Socket with Pako Switch	IP65	1	4



## 5/160A. (3P+E+N)

380V. 50/60 Hz. 7h  
(Polyamid 6)



# 5 Contact CEE Norm Series



Product Code	Descriptions	IP	Box	Pack
BC1-8505-7011	5/160A. Straight Plug	IP67	1	8
BC1-8505-7312	5/160A. Connector Socket	IP67	1	8
BC1-8505-7413	5/160A. Panel Mounted Socket	IP67	1	8
BC1-8505-7114	5/160A. Panel Mounted Plug	IP67	1	8
BC1-8505-7420	5/160A. 45° Angled Panel Mounted Socket	IP67	1	8
BC1-8505-7236	5/160A. 90° Angled Surface Plug	IP67	1	4
BC1-8505-7535	5/160A. 90° Angled Surface Socket	IP67	1	4
BC1-8505-7238	5/160A. 90° Angled Surface Plug with Schuko	IP67	1	4
BC1-8505-7537	5/160A. 90° Angled Surface Socket with Schuko	IP67	1	4
BC1-8505-7240	5/160A. 90° Angled Surface Plug with Pako Switch	IP65	1	4
BC1-8505-7550	5/160A. 90° Angled Surface Socket with Pako Switch	IP65	1	4





## 3/16A. (2P+E) 220V. 50/60 Hz. 6h (Polyamid 6)

**IP44**



Product Code	Descriptions	IP	Box	Pack
BCS-1403-2011	3/16A. Straight Plug	IP44	10	120
BCS-1403-2312	3/16A. Connector Socket	IP44	10	120
BCS-1403-2413	3/16A. Panel Mounted Socket	IP44	15	120
BCS-1403-2114	3/16A. Panel Mounted Plug	IP44	10	120
BCS-1403-2420	3/16A. 45° Angled Panel Mounted Socket	IP44	8	96

**IP67**



Product Code	Descriptions	IP	Box	Pack
BCS-1403-7011	3/16A. Straight Plug	IP67	8	96
BCS-1403-7312	3/16A. Connector Socket	IP67	8	96
BCS-1403-7413	3/16A. Panel Mounted Socket	IP67	8	96
BCS-1403-7114	3/16A. Panel Mounted Plug	IP67	10	120
BCS-1403-7420	3/16A. 45° Angled Panel Mounted Socket	IP67	6	72



## 4/16A. (3P+E) 380V. 50/60 Hz. 6h (Polyamid 6)

**IP44**



Product Code	Descriptions	IP	Box	Pack
BCS-1504-2011	4/16A. Straight Plug	IP44	8	96
BCS-1504-2312	4/16A. Connector Socket	IP44	8	96
BCS-1504-2413	4/16A. Panel Mounted Socket	IP44	15	120
BCS-1504-2114	4/16A. Panel Mounted Plug	IP44	10	120
BCS-1504-2420	4/16A. 45° Angled Panel Mounted Socket	IP44	8	96

**IP67**



Product Code	Descriptions	IP	Box	Pack
BCS-1504-7011	4/16A. Straight Plug	IP67	6	72
BCS-1504-7312	4/16A. Connector Socket	IP67	6	72
BCS-1504-7413	4/16A. Panel Mounted Socket	IP67	6	72
BCS-1504-7114	4/16A. Panel Mounted Plug	IP67	10	120
BCS-1504-7420	4/16A. 45° Angled Panel Mounted Socket	IP67	6	72



## 5/16A. (3P+E+N) 380V. 50/60 Hz. 6h (Polyamid 6)

**IP44**



Product Code	Descriptions	IP	Box	Pack
BCS-1505-2011	5/16A. Straight Plug	IP44	8	96
BCS-1505-2312	5/16A. Connector Socket	IP44	8	96
BCS-1505-2413	5/16A. Panel Mounted Socket	IP44	15	120
BCS-1505-2114	5/16A. Panel Mounted Plug	IP44	8	96
BCS-1505-2420	5/16A. 45° Angled Panel Mounted Socket	IP44	6	72

**IP67**



Product Code	Descriptions	IP	Box	Pack
BCS-1505-7011	5/16A. Straight Plug	IP67	4	48
BCS-1505-7312	5/16A. Connector Socket	IP67	4	48
BCS-1505-7413	5/16A. Panel Mounted Socket	IP67	6	72
BCS-1505-7114	5/16A. Panel Mounted Plug	IP67	6	72
BCS-1505-7420	5/16A. 45° Angled Panel Mounted Socket	IP67	6	72

# Light and Sound Systems Black Series



## 3/32A. (2P+E) 220V. 50/60 Hz. 6h (Polyamid 6)

Product Code	Descriptions	IP	Box	Pack
BCS-3403-2011	3/32A. Straight Plug	IP44	8	64
BCS-3403-2312	3/32A. Connector Socket	IP44	8	64
BCS-3403-2413	3/32A. Panel Mounted Socket	IP44	8	64
BCS-3403-2114	3/32A. Panel Mounted Plug	IP44	8	96
BCS-3403-2420	3/32A. 45° Angled Panel Mounted Socket	IP44	4	48

**IP44**



Product Code	Descriptions	IP	Box	Pack
BCS-3403-7011	3/32A. Straight Plug	IP67	3	36
BCS-3403-7312	3/32A. Connector Socket	IP67	3	36
BCS-3403-7413	3/32A. Panel Mounted Socket	IP67	4	48
BCS-3403-7114	3/32A. Panel Mounted Plug	IP67	6	72
BCS-3403-7420	3/32A. 45° Angled Panel Mounted Socket	IP67	4	48

**IP67**



## 4/32A. (3P+E) 380V. 50/60 Hz. 6h (Polyamid 6)

Product Code	Descriptions	IP	Box	Pack
BCS-3504-2011	4/32A. Straight Plug	IP44	8	64
BCS-3504-2312	4/32A. Connector Socket	IP44	8	64
BCS-3504-2413	4/32A. Panel Mounted Socket	IP44	8	64
BCS-3504-2114	4/32A. Panel Mounted Plug	IP44	8	96
BCS-3504-2420	4/32A. 45° Angled Panel Mounted Socket	IP44	4	48

**IP44**



Product Code	Descriptions	IP	Box	Pack
BCS-3504-7011	4/32A. Straight Plug	IP67	3	36
BCS-3504-7312	4/32A. Connector Socket	IP67	3	36
BCS-3504-7413	4/32A. Panel Mounted Socket	IP67	4	48
BCS-3504-7114	4/32A. Panel Mounted Plug	IP67	6	72
BCS-3504-7420	4/32A. 45° Angled Panel Mounted Socket	IP67	4	48

**IP67**



## 5/32A. (3P+E+N) 380V. 50/60 Hz. 6h (Polyamid 6)

Product Code	Descriptions	IP	Box	Pack
BCS-3505-2011	5/32A. Straight Plug	IP44	8	64
BCS-3505-2312	5/32A. Connector Socket	IP44	8	64
BCS-3505-2413	5/32A. Panel Mounted Socket	IP44	8	64
BCS-3505-2114	5/32A. Panel Mounted Plug	IP44	8	96
BCS-3505-2420	5/32A. 45° Angled Panel Mounted Socket	IP44	6	72

**IP44**



Product Code	Descriptions	IP	Box	Pack
BCS-3505-7011	5/32A. Straight Plug	IP67	3	36
BCS-3505-7312	5/32A. Connector Socket	IP67	3	36
BCS-3505-7413	5/32A. Panel Mounted Socket	IP67	4	48
BCS-3505-7114	5/32A. Panel Mounted Plug	IP67	6	72
BCS-3505-7420	5/32A. 45° Angled Panel Mounted Socket	IP67	4	48

**IP67**





## 3/63A. (2P+E) 220V. 50/60 Hz. 6h (Polyamid 6)

IP44			Product Code	Descriptions	IP	Box	Pack
			BCS-4403-2011	3/63A. Straight Plug	IP44	1	12
			BCS-4403-2312	3/63A. Connector Socket	IP44	1	12
			BCS-4403-2413	3/63A. Panel Mounted Socket	IP44	1	24
			BCS-4403-2114	3/63A. Panel Mounted Plug	IP44	1	24
			BCS-4403-2420	3/63A. 45° Angled Panel Mounted Socket	IP44	1	24
IP67			Product Code	Descriptions	IP	Box	Pack
			BCS-4403-7011	3/63A. Straight Plug	IP67	1	12
			BCS-4403-7312	3/63A. Connector Socket	IP67	1	12
			BCS-4403-7413	3/63A. Panel Mounted Socket	IP67	1	24
			BCS-4403-7114	3/63A. Panel Mounted Plug	IP67	1	24
			BCS-4403-7420	3/63A. 45° Angled Panel Mounted Socket	IP67	1	24



## 4/63A. (3P+E) 380V. 50/60 Hz. 6h (Polyamid 6)

IP44			Product Code	Descriptions	IP	Box	Pack
			BCS-4504-2011	4/63A. Straight Plug	IP44	1	12
			BCS-4504-2312	4/63A. Connector Socket	IP44	1	12
			BCS-4504-2413	4/63A. Panel Mounted Socket	IP44	1	24
			BCS-4504-2114	4/63A. Panel Mounted Plug	IP44	1	24
			BCS-4504-2420	4/63A. 45° Angled Panel Mounted Socket	IP44	1	24
IP67			Product Code	Descriptions	IP	Box	Pack
			BCS-4504-7011	4/63A. Straight Plug	IP67	1	12
			BCS-4504-7312	4/63A. Connector Socket	IP67	1	12
			BCS-4504-7413	4/63A. Panel Mounted Socket	IP67	1	24
			BCS-4504-7114	4/63A. Panel Mounted Plug	IP67	1	24
			BCS-4504-7420	4/63A. 45° Angled Panel Mounted Socket	IP67	1	24



## 5/63A. (3P+E+N) 380V. 50/60 Hz. 6h (Polyamid 6)

IP44			Product Code	Descriptions	IP	Box	Pack
			BCS-4505-2011	5/63A. Straight Plug	IP44	1	12
			BCS-4505-2312	5/63A. Connector Socket	IP44	1	12
			BCS-4505-2413	5/63A. Panel Mounted Socket	IP44	1	24
			BCS-4505-2114	5/63A. Panel Mounted Plug	IP44	1	24
			BCS-4505-2420	5/63A. 45° Angled Panel Mounted Socket	IP44	1	24
IP67			Product Code	Descriptions	IP	Box	Pack
			BCS-4505-7011	5/63A. Straight Plug	IP67	1	12
			BCS-4505-7312	5/63A. Connector Socket	IP67	1	12
			BCS-4505-7413	5/63A. Panel Mounted Socket	IP67	1	24
			BCS-4505-7114	5/63A. Panel Mounted Plug	IP67	1	24
			BCS-4505-7420	5/63A. 45° Angled Panel Mounted Socket	IP67	1	24

# Light and Sound Systems Black Series



## 3/125A. (2P+E) 220V. 50/60 Hz. 6h (Polyamid 6)

Product Code	Descriptions	IP	Box	Pack
BCS-6403-7011	3/125A. Straight Plug	IP67	1	8
BCS-6403-7312	3/125A. Connector Socket	IP67	1	8
BCS-6403-7413	3/125A. Panel Mounted Socket	IP67	1	8
BCS-6403-7114	3/125A. Panel Mounted Plug	IP67	1	8
BCS-6403-7420	3/125A. 45° Angled Panel Mounted Socket	IP67	1	8



## 4/125A. (3P+E) 380V. 50/60 Hz. 6h (Polyamid 6)

Product Code	Descriptions	IP	Box	Pack
BCS-6504-7011	4/125A. Straight Plug	IP67	1	8
BCS-6504-7312	4/125A. Connector Socket	IP67	1	8
BCS-6504-7413	4/125A. Panel Mounted Socket	IP67	1	8
BCS-6504-7114	4/125A. Panel Mounted Plug	IP67	1	8
BCS-6504-7420	4/125A. 45° Angled Panel Mounted Socket	IP67	1	8



## 5/125A. (3P+E+N) 380V. 50/60 Hz. 6h (Polyamid 6)

Product Code	Descriptions	IP	Box	Pack
BCS-6505-7011	5/125A. Straight Plug	IP67	1	8
BCS-6505-7312	5/125A. Connector Socket	IP67	1	8
BCS-6505-7413	5/125A. Panel Mounted Socket	IP67	1	8
BCS-6505-7114	5/125A. Panel Mounted Plug	IP67	1	8
BCS-6505-7420	5/125A. 45° Angled Panel Mounted Socket	IP67	1	8



## Light-reflective matte raw material



**Inverter Connector**

**Inverter Plug**



Changing phase, only 5 seconds on 3 phase motors inversion problem happen for mobile machines, solve this problem with screwdriver only 5 seconds

**5/16A.** BC1-1505-2050  
**5/32A.** BC1-3505-2050

IP44

**5/16A.** BC1-1505-2080  
**5/32A.** BC1-3505-2080

IP44

**5/16A.** BC1-1505-2070  
**5/32A.** BC1-3505-2070

IP44

**5/16A.** BC1-1505-2060  
**5/32A.** BC1-3505-2060

IP44

**5/16A.** BC1-1505-7050  
**5/32A.** BC1-3505-7050

IP67

**5/16A.** BC1-1505-7070  
**5/32A.** BC1-3505-7070

IP67

**5/16A.** BC1-1505-7060  
**5/32A.** BC1-3505-7060

IP67

**5/16A.** BC1-1505-2061  
**5/32A.** BC1-3505-2061

IP44



**5 YEAR  
WARRANTY**

**24 Volt**

24 Volt  
*CEE Norm Plug and Socket Series*





Product Code	Descriptions	IP	Box	Pack
BC1-1102-2011	2/16A. Straight Plug	IP44	10	120
BC1-1102-2312	2/16A. Connector Socket	IP44	10	120
BC1-1102-2414	2/16A. Panel Mounted Socket (One Piece)	IP44	20	160
BC1-1102-2413	2/16A. Panel Mounted Socket	IP44	15	120
BC1-1102-2114	2/16A. Panel Mounted Plug	IP44	10	120
BC1-1102-2210	2/16A. Surface Mounted Plug	IP44	6	72
BC1-1102-2236	2/16A. 90° Angled Surface Plug	IP44	6	48
BC1-1102-2510	2/16A. Surface Mounted Socket	IP44	6	72
BC1-1102-2535	2/16A. 90° Angled Surface Socket	IP44	3	36



Product Code	Descriptions	IP	Box	Pack
BC1-1102-7011	2/16A. Straight Plug	IP67	8	96
BC1-1102-7312	2/16A. Connector Socket	IP67	8	96
BC1-1102-7414	2/16A. Panel Mounted Socket (One Piece)	IP67	8	96
BC1-1102-7413	2/16A. Panel Mounted Socket	IP67	8	96
BC1-1102-7114	2/16A. Panel Mounted Plug	IP67	8	96
BC1-1102-7210	2/16A. Surface Mounted Plug	IP67	4	48
BC1-1102-7236	2/16A. 90° Angled Surface Plug	IP67	3	36
BC1-1102-7510	2/16A. Surface Mounted Socket	IP67	4	48
BC1-1102-7535	2/16A. 90° Angled Surface Socket	IP67	3	36





# 24V. Series



**CEE Norm**  
**3/16A. (3P) (Polyamid 6)**



Product Code	Descriptions	IP	Box	Pack
BC1-1103-2011	3/16A. Straight Plug	IP44	10	120
BC1-1103-2312	3/16A. Connector Socket	IP44	10	120
BC1-1103-2414	3/16A. Panel Mounted Socket (One Piece)	IP44	20	160
BC1-1103-2413	3/16A. Panel Mounted Socket	IP44	15	120
BC1-1103-2114	3/16A. Panel Mounted Plug	IP44	10	120
BC1-1103-2210	3/16A. Surface Mounted Plug	IP44	6	72
BC1-1103-2236	3/16A. 90° Angled Surface Plug	IP44	6	48
BC1-1103-2510	3/16A. Surface Mounted Socket	IP44	6	72
BC1-1103-2535	3/16A. 90° Angled Surface Socket	IP44	3	36



Product Code	Descriptions	IP	Box	Pack
BC1-1103-7011	3/16A. Straight Plug	IP67	8	96
BC1-1103-7312	3/16A. Connector Socket	IP67	8	96
BC1-1103-7414	3/16A. Panel Mounted Socket (One Piece)	IP67	8	96
BC1-1103-7413	3/16A. Panel Mounted Socket	IP67	8	96
BC1-1103-7114	3/16A. Panel Mounted Plug	IP67	8	96
BC1-1103-7210	3/16A. Surface Mounted Plug	IP67	4	48
BC1-1103-7236	3/16A. 90° Angled Surface Plug	IP67	3	36
BC1-1103-7510	3/16A. Surface Mounted Socket	IP67	4	48
BC1-1103-7535	3/16A. 90° Angled Surface Socket	IP67	3	36





Product Code	Descriptions	IP	Box	Pack
BC1-3102-2011	2/32A. Straight Plug	IP44	10	120
BC1-3102-2312	2/32A. Connector Socket	IP44	10	120
BC1-3102-2414	2/32A. Panel Mounted Socket (One Piece)	IP44	20	160
BC1-3102-2413	2/32A. Panel Mounted Socket	IP44	15	120
BC1-3102-2114	2/32A. Panel Mounted Plug	IP44	10	120
BC1-3102-2210	2/32A. Surface Mounted Plug	IP44	6	72
BC1-3102-2236	2/32A. 90° Angled Surface Plug	IP44	6	48
BC1-3102-2510	2/32A. Surface Mounted Socket	IP44	6	72
BC1-3102-2535	2/32A. 90° Angled Surface Socket	IP44	3	36



Product Code	Descriptions	IP	Box	Pack
BC1-3102-7011	2/32A. Straight Plug	IP67	8	96
BC1-3102-7312	2/32A. Connector Socket	IP67	8	96
BC1-3102-7414	2/32A. Panel Mounted Socket (One Piece)	IP67	8	96
BC1-3102-7413	2/32A. Panel Mounted Socket	IP67	8	96
BC1-3102-7114	2/32A. Panel Mounted Plug	IP67	8	96
BC1-3102-7210	2/32A. Surface Mounted Plug	IP67	4	48
BC1-3102-7236	2/32A. 90° Angled Surface Plug	IP67	3	36
BC1-3102-7510	2/32A. Surface Mounted Socket	IP67	4	48
BC1-3102-7535	2/32A. 90° Angled Surface Socket	IP67	3	36



# 24V. Series



**CEE Norm**  
**3/32A. (3P) (Polyamid 6)**



Product Code	Descriptions	IP	Box	Pack
BC1-3103-2011	3/32A. Straight Plug	IP44	10	120
BC1-3103-2312	3/32A. Connector Socket	IP44	10	120
BC1-3103-2414	3/32A. Panel Mounted Socket (One Piece)	IP44	20	160
BC1-3103-2413	3/32A. Panel Mounted Socket	IP44	15	120
BC1-3103-2114	3/32A. Panel Mounted Plug	IP44	10	120
BC1-3103-2210	3/32A. Surface Mounted Plug	IP44	6	72
BC1-3103-2236	3/32A. 90° Angled Surface Plug	IP44	6	48
BC1-3103-2510	3/32A. Surface Mounted Socket	IP44	6	72
BC1-3103-2535	3/32A. 90° Angled Surface Socket	IP44	3	36



Product Code	Descriptions	IP	Box	Pack
BC1-3103-7011	3/32A. Straight Plug	IP67	8	96
BC1-3103-7312	3/32A. Connector Socket	IP67	8	96
BC1-3103-7414	3/32A. Panel Mounted Socket (One Piece)	IP67	8	96
BC1-3103-7413	3/32A. Panel Mounted Socket	IP67	8	96
BC1-3103-7114	3/32A. Panel Mounted Plug	IP67	8	96
BC1-3103-7210	3/32A. Surface Mounted Plug	IP67	4	48
BC1-3103-7236	3/32A. 90° Angled Surface Plug	IP67	3	36
BC1-3103-7510	3/32A. Surface Mounted Socket	IP67	4	48
BC1-3103-7535	3/32A. 90° Angled Surface Socket	IP67	3	36

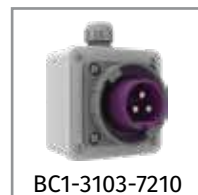

**NEW**  
**POWERBOX**  
**SERIES**





5 YEAR  
WARRANTY

**BEMBOX**

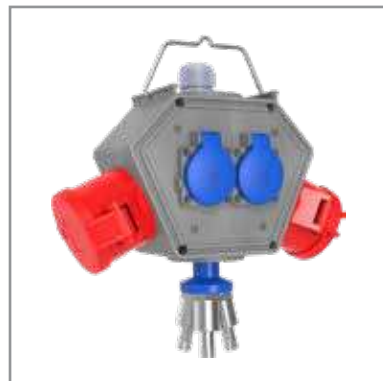
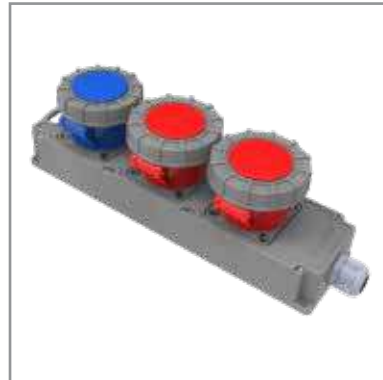

(Polyamide 6) Body



Product Code	Description	IP	Box	Pack
BG4-100X-0X0X	Group Socket Box (Imperforate)	IP44	1	24
BG4-100Y-0Y0Y	Group Socket Box (Big Hole)	IP44	1	24
BG4-1010-1010	1/16A. 220V. <b>3 Pcs.</b>	IP44	1	12
BG4-1014-1414	3/16A. 220V. <b>3 Pcs.</b>	IP44	1	12
BG4-1016-1010	5/16A. 380V. <b>1 Pc.</b> + 1/16A. 220V. <b>2 Pcs.</b>	IP44	1	12
BG4-1016-1610	5/16A. 380V. <b>2 Pcs.</b> + 1/16A. 220V. <b>1 Pc.</b>	IP44	1	12
BG4-1016-1614	5/16A. 380V. <b>2 Pcs.</b> + 3/16A. 220V. <b>1 Pc.</b>	IP44	1	12
BG4-1016-1616	5/16A. 380V. <b>3 Pcs.</b>	IP44	1	12
BG4-1017-1717	3/32A. 220V. <b>3 Pcs.</b>	IP44	1	12
BG4-1018-1818	4/32A. 380V. <b>3 Pcs.</b>	IP44	1	12
BG4-1019-1010	5/32A. 380V. <b>1 Pc.</b> + 1/16A. 220V. <b>2 Pcs.</b>	IP44	1	12
BG4-1019-1514	5/32A. 380V. <b>1 Pc.</b> + 4/16A. 380V. <b>1 Pc.</b> + 3/16A. 220V. <b>1 Pc.</b>	IP44	1	12
BG4-1019-1614	5/32A. 380V. <b>1 Pc.</b> + 5/16A. 380V. <b>1 Pc.</b> + 3/16A. 220V. <b>1 Pc.</b>	IP44	1	12
BG4-1019-1910	5/32A. 380V. <b>2 Pcs.</b> + 1/16A. 220V. <b>1 Pc.</b>	IP44	1	12
BG4-1019-1914	5/32A. 380V. <b>2 Pcs.</b> + 3/16A. 220V. <b>1 Pc.</b>	IP44	1	12
BG4-1019-1916	5/32A. 380V. <b>2 Pcs.</b> + 5/16A. 380V. <b>1 Pc.</b>	IP44	1	12
BG4-1019-1917	5/32A. 380V. <b>2 Pcs.</b> + 3/32A. 220V. <b>1 Pc.</b>	IP44	1	12
BG4-1019-1919	5/32A. 380V. <b>3 Pcs.</b>	IP44	1	12
BG4-101K-1K1K	2/16A. 24V. <b>3 Pcs.</b>	IP44	1	12
BG4-101L-1K1K	3/16A. 24V. <b>1 Pc.</b> + 2/16A. 24V. <b>2 Pcs.</b>	IP44	1	12
BG4-101L-1L1L	3/16A. 24V. <b>3 Pcs.</b>	IP44	1	12
BG4-101M-1K1K	2/32A. 24V. <b>1 Pc.</b> + 2/16A. 24V. <b>2 Pcs.</b>	IP44	1	12
BG4-101M-1M1M	2/32A. 24V. <b>3 Pcs.</b>	IP44	1	12
BG4-101N-1L1L	3/32A. 24V. <b>1 Pc.</b> + 3/16A. 24V. <b>2 Pcs.</b>	IP44	1	12
BG4-101N-1M1M	3/32A. 24V. <b>1 Pc.</b> + 2/32A. 24V. <b>2 Pcs.</b>	IP44	1	12
BG4-101N-1N1N	3/32A. 24V. <b>3 Pcs.</b>	IP44	1	12
BG4-111Y-1Y1Y	Group Socket Box Yellow (Big Hole)	IP44	1	24
BG4-101T-1T1T	1/16A. 220V. <b>3 Pcs.</b> Thermal Fuse	IP44	1	12

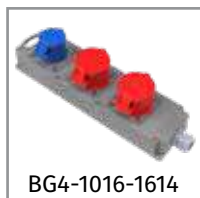

Note: Our yellow colour group socket box product is produced to order with a minimum of 100 pcs.

(Polyamide 6) Body

Product Code	Description	IP	Box	Pack
BG6-100X-0X0X	Group Socket Box (Imperforate)	IP67	1	24
BG6-1010-1010	3/16A. 220V. 3 Pcs.	IP67	1	12
BG6-1014-1414	5/16A. 380V. 1 Pc. + 1/16A. 220V. 2 Pcs.	IP67	1	12
BG6-1016-1010	5/16A. 380V. 1 Pc. + 3/16A. 220V. 1 Pc. + 1/16A. 220V. 1 Pc.	IP67	1	12
BG6-1016-1410	5/16A. 380V. 2 Pcs. + 1/16A. 220V. 1 Pc.	IP67	1	12
BG6-1016-1610	5/16A. 380V. 2 Pcs. + 3/16A. 220V. 1 Pc.	IP67	1	12
BG6-1016-1614	5/16A. 380V. 3 Pcs.	IP67	1	12
BG6-1016-1616	3/32A. 220V. 3 Pcs.	IP67	1	12
BG6-1017-1717	4/32A. 380V. 3 Pcs.	IP67	1	12
BG6-1018-1818	5/32A. 380V. 1 Pc. + 1/16A. 220V. 2 Pcs.	IP67	1	12
BG6-1019-1010	5/32A. 380V. 2 Pcs. + 1/16A. 220V. 1 Pc.	IP67	1	12
BG6-1019-1910	5/32A. 380V. 2 Pcs. + 3/16A. 220V. 1 Pc.	IP67	1	12
BG6-1019-1914	5/32A. 380V. 2 Pcs. + 5/16A. 380V. 1 Pc.	IP67	1	12
BG6-1019-1916	5/32A. 380V. 2 Pcs. + 3/32A. 220V. 1 Pc.	IP67	1	12
BG6-1019-1917	5/32A. 380V. 3 Pcs.	IP67	1	12
BG6-1019-1919	2/16A. 24V. 3 Pcs.	IP67	1	12
BG6-101K-1K1K	3/16A. 24V. 1 Pc. + 2/16A. 24V. 2 Pcs.	IP67	1	12
BG6-101L-1K1K	3/16A. 24V. 3 Pcs.	IP67	1	12
BG6-101L-1L1L	2/32A. 24V. 1 Pc. + 2/16A. 24V. 2 Pcs.	IP67	1	12
BG6-101M-1K1K	2/32A. 24V. 3 Pcs.	IP67	1	12
BG6-101M-1M1M	3/32A. 24V. 1 Pc. + 3/16A. 24V. 2 Pcs.	IP67	1	12
BG6-101N-1L1L	3/32A. 24V. 1 Pc. + 2/32A. 24V. 2 Pcs.	IP67	1	12
BG6-101N-1M1M	3/32A. 24V. 3 Pcs.	IP67	1	12
BG6-101N-1N1N	1/16A. 220V. 3 Pcs.	IP67	1	12



**Modular 3-Socket Set**  
Compatible with all 16A and 32A plug and socket types, this modular set provides a versatile and reliable connection solution for various industrial applications.



Our IP67 Tribox products are suitable for 75X75 cm frame

# NO TO THE MESS

possibility of using air hoses and electrical cables from the air



  
**bemis**<sup>®</sup>



 **Polybox**<sup>®</sup>



Product Code	Descriptions	IP	Box	Pack
BX1-0000-0000	CEE Norm Unplugged Box	IP44	1	6
BX1-0111-0000	CEE Norm 1/16A. 3 Pcs. Box	IP44	1	6
BX1-0TTT-0000	CEE Norm 1/16A. 3 Pcs. Themal Fuse Box	IP44	1	6
BX1-0222-0000	CEE Norm 3/16A. 3 Pcs. Box	IP44	1	6
BX1-0222-2100	CEE Norm 3/16A. 3 Pcs. + 1/16A. 2 Pcs. Box	IP44	1	6
BX1-0333-0000	CEE Norm 4/16A. 3 Pcs. Box	IP44	1	6
BX1-0333-2100	CEE Norm 4/16A. 3 Pcs. + 1/16A. 2 Pcs. Box	IP44	1	6
BX1-0441-0000	CEE Norm 5/16A. 2 Pcs. + 1/16A. 1 Pc. Box	IP44	1	6
BX1-0444-0000	CEE Norm 5/16A. 3 Pcs. Box	IP44	1	6
BX1-0444-2100	CEE Norm 5/16A. 3 Pcs. + 1/16A. 2 Pcs. Box	IP44	1	6
BX1-0442-2100	CEE Norm 5/16A. 2 Pcs. + 3/16A. 1 Pc. + 1/16A. 2 Pcs. Box	IP44	1	6
BX1-0555-0000	CEE Norm 3/32A. 3 Pcs. Box	IP44	1	6
BX1-0666-0000	CEE Norm 4/32A. 3 Pcs. Box	IP44	1	6
BX1-0666-2100	CEE Norm 4/32A. 3 Pcs. + 1/16A. 2 Pcs. Box	IP44	1	6
BX1-0771-0000	CEE Norm 5/32A. 2 Pcs. + 1/16A. 1 Pc. Box	IP44	1	6
BX1-0777-0000	CEE Norm 5/32A. 3 Pcs. Box	IP44	1	6
BX1-0777-2100	CEE Norm 5/32A. 3 Pcs. + 1/16A. 2 Pcs. Box	IP44	1	6
BX1-0777-7210	CEE Norm 5/32A. 4 Pcs. + 1/16A. 2 Pcs. Box	IP44	1	6
BX1-0KKK-0000	CEE Norm 2/16A. 24V. 3 Pcs. Box	IP44	1	6
BX1-0LLL-0000	CEE Norm 3/16A. 24V. 3 Pcs. Box	IP44	1	6
BX1-0MMM-0000	CEE Norm 2/32A. 24V. 3 Pcs. Box	IP44	1	6
BX1-0NNN-0000	CEE Norm 3/32A. 24V. 3 Pcs. Box	IP44	1	6

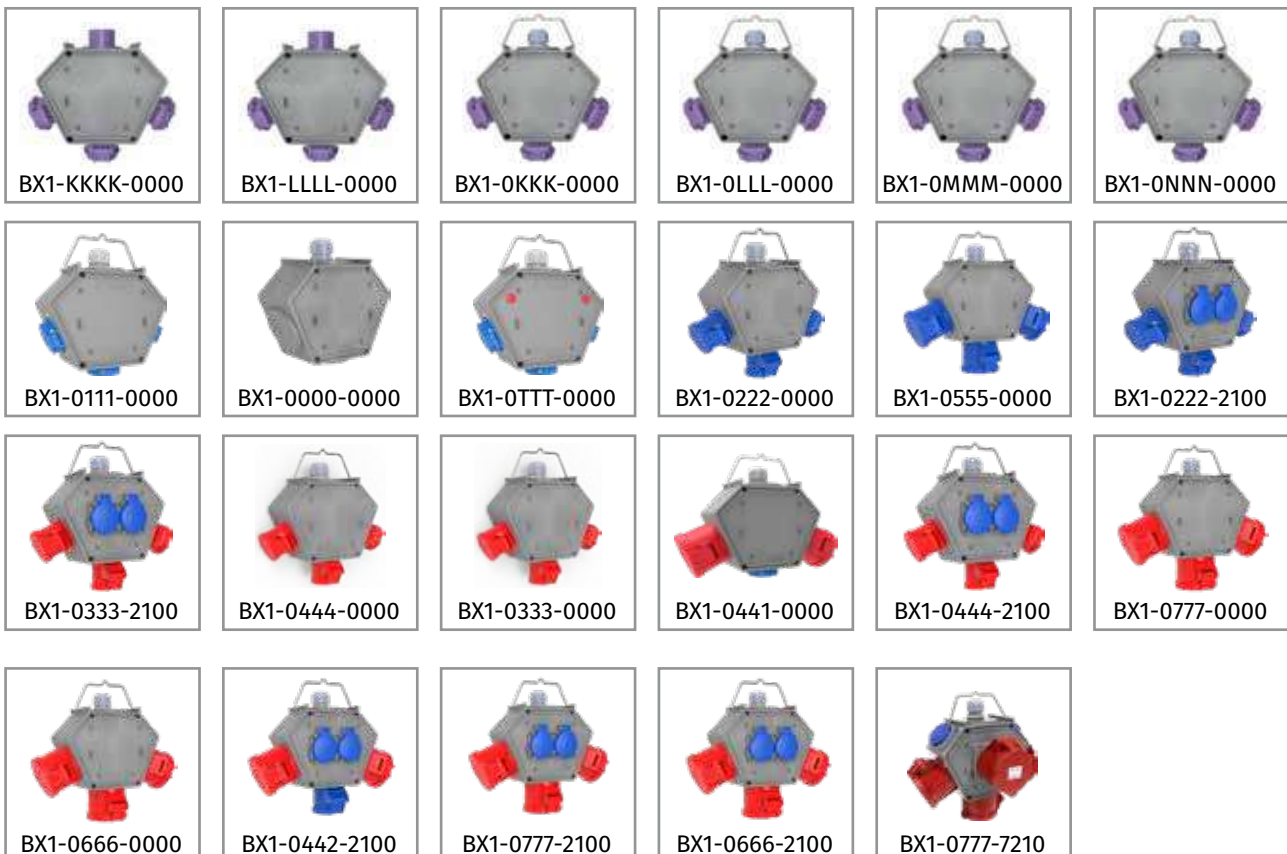

## POLYBOX WITH PLUG

(Polyamide 6) Body

Product Code	Descriptions	IP	Box	Pack
BX1-1222-0000	CEE Norm 3/16A. 3 Pcs. + 3/32A. Plug Box	IP44	1	6
BX1-1222-2100	CEE Norm 3/16A. 3 Pcs. + 1/16A. 2 Pcs. + 3/32A. Plug Box	IP44	1	6
BX1-3444-0000	CEE Norm 5/16A. 3 Pcs. + 5/32A. Plug Box	IP44	1	6
BX1-7444-0000	CEE Norm 5/16A. 3 Pcs. + 5/16A. Plug Box	IP44	1	6
BX1-KKKK-0000	CEE Norm 2/16A. 24V. 3 Pcs. + 2/16A. 24V. Plug Box	IP44	1	6
BX1-LLLL-0000	CEE Norm 3/16A. 24V. 3 Pcs. + 3/16A. 24V. Plug Box	IP44	1	6

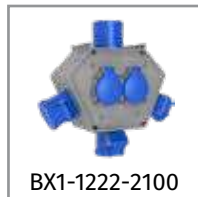

## POLYBOX WITH CABLE

(Polyamide 6) Body

Product Code	Descriptions	IP	Box	Pack
BX1K0333-2100	CEE Norm 4/16A. 3 Pcs. + 1/16A. 2 Pcs. 1,5m Cable Box	IP44	1	6
BX1K0444-2100	CEE Norm 5/16A. 3 Pcs. + 1/16A. 2 Pcs. + 1,5m Cable Box	IP44	1	6
BX1K3444-4000	CEE Norm 5/16A. 4 Pcs. + 5/32A. 1 Pc. Plug + 1,5m Cable	IP44	1	6
BX1K0777-0000	CEE Norm 5/32A. 3 Pcs. + 1,5m Cable Box	IP44	1	6
BX1K0550-2113	CEE Norm 3/32A. 2 Pcs. + 1/16A. 2 Pcs. + 1,5m Cab. 3 Air Outlet Box	IP44	1	6
BX1K0660-2113	CEE Norm 4/32A. 2 Pcs. + 1/16A. 2 Pcs. + 1,5m Cab. 3 Air Outlet Box	IP44	1	6
BX1K0770-0013	CEE Norm 5/32A. 2 Pcs. + 1,5m Cable, 3 Air Outlet Box	IP44	1	6





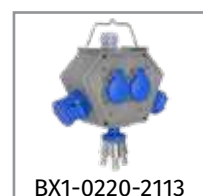

## POLYBOX WITH AIR OUTLET

(Polyamide 6) Body

Product Code	Descriptions	IP	Box	Pack
BX1-0110-2113	CEE Norm 1/16A. 4 Pcs. + 3 Air Outlet Box	IP44	1	6
BX1-0220-2113	CEE Norm 3/16A. 2 Pcs. + 1/16A. 2Pcs. 3 Air Outlet Box	IP44	1	6
BX1-0222-2113	CEE Norm 3/16A. 3 Pcs. + 1/16A. 2 Pcs. + 3 Air Outlet Box	IP44	1	6
BX1-0330-2113	CEE Norm 4/16A. 2 Pcs. + 1/16A. 2 Pcs. 3 Air Outlet Box	IP44	1	6
BX1-0440-2113	CEE Norm 5/16A. 2 Pcs. + 1/16A. 2 Pcs. + 3 Air Outlet Box	IP44	1	6
BX1-0777-2113	CEE Norm 5/32A 3 Pcs. 1/16A 2A Pcs. 3 Air Outlet Box	IP44	1	6
BX1-0550-2113	CEE Norm 3/32A. 2 Pcs. + 1/16A. 2 Pcs. + 3 Air Outlet Box	IP44	1	6
BX1-0660-2113	CEE Norm 4/32A. 2 Pcs. + 1/16A. 2 Pcs. + 3 Air Outlet Box	IP44	1	6



**120x255x80mm**

 Thermal Fuse  
 PG16 / PG21 Rekor  
 ABS  
 IP44  
 1

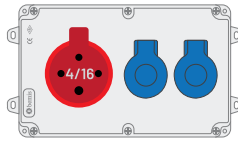

BKP-7215-2000

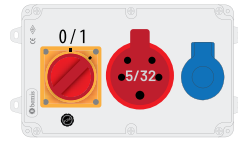

BKP-7219-1002

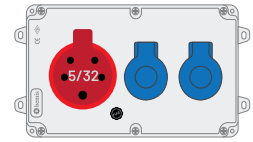

BKP-7219-2009



BKP-7216-1001

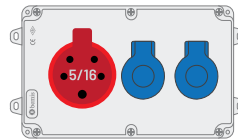

BKP-7216-2000

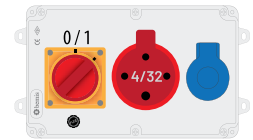

BKP-7218-1002

**210x300x90mm**

 Thermal Fuse  
 PG16 / PG21 Rekor  
 ABS  
 IP44  
 1

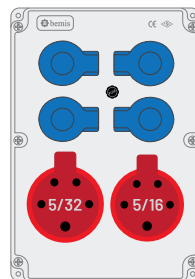

BKP-8296-4009

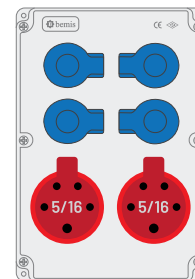

BKP-8226-4000

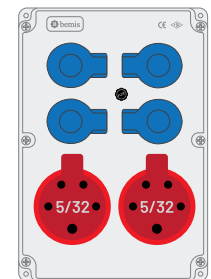

BKP-8229-4009

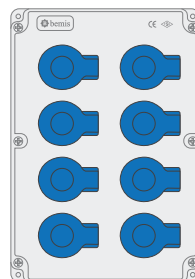

BKP-8280-0000

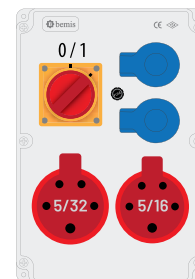

BKP-8296-2002

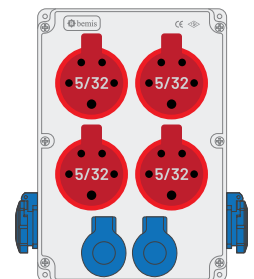

BKP-8249-4000

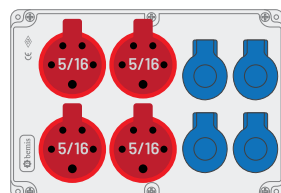

BKP-8246-4000

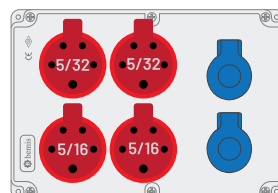

BKP-8229-2620

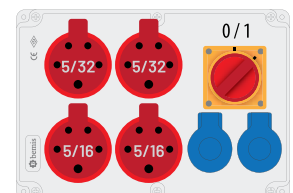

BKP-8229-2621

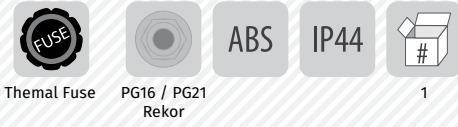

**Handled Powerbox**  
**120x255x80mm**

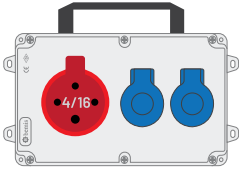

BKP-7215-2007

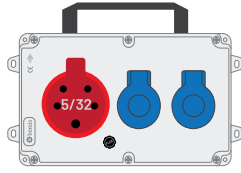

BKP-7219-2003

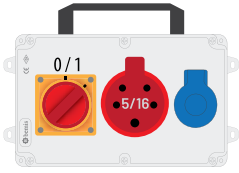

BKP-7216-1008

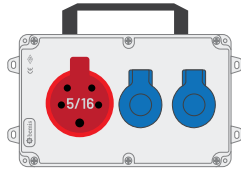

BKP-7216-2007

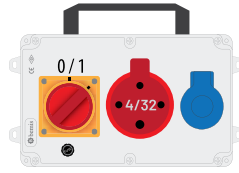

BKP-7218-1004



**Handled Powerbox**  
**210x300x90mm**

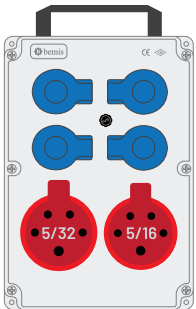

BKP-8219-1643

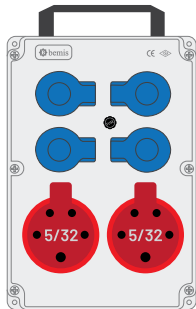

BKP-8229-4003

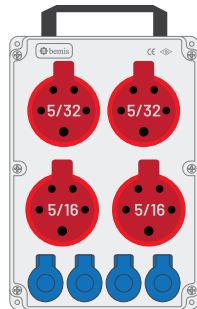

BKP-8229-2647

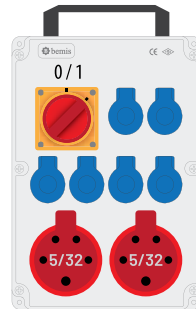

BKP-8229-6008

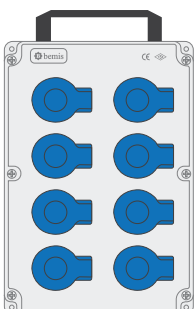

BKP-8280-0007

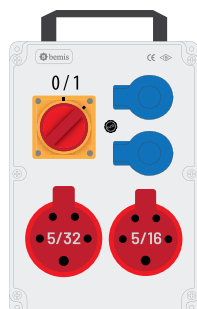

BKP-8296-2004

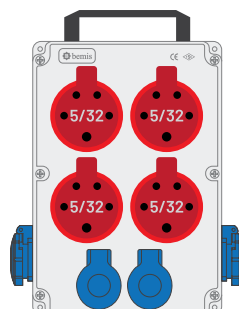

BKP-8249-4007

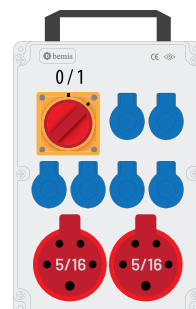

BKP-8226-6008

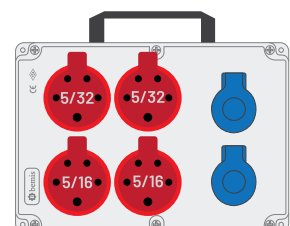

BKP-8229-2627

## Handled Cabled Powerbox 120x255x80mm

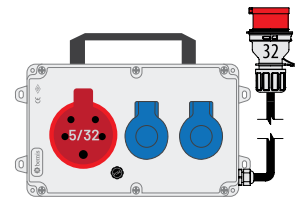
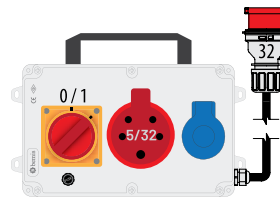
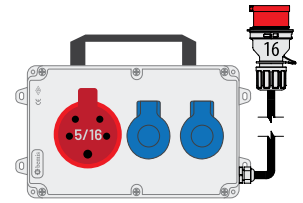
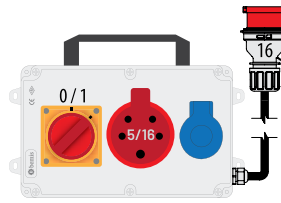
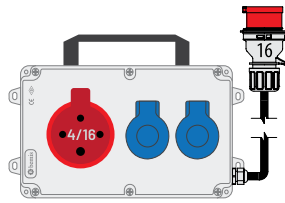
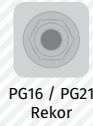
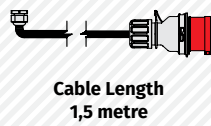

## Handled Cabled Powerbox 210x300x90mm

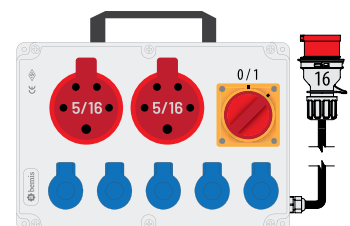
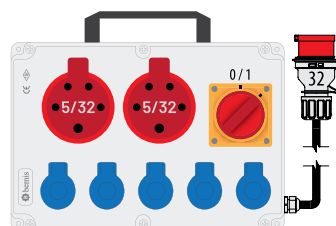
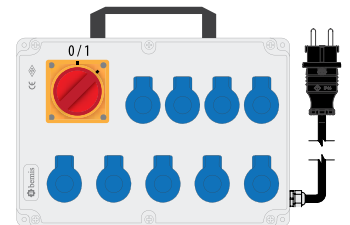
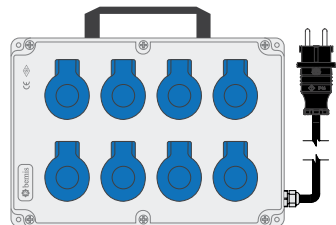
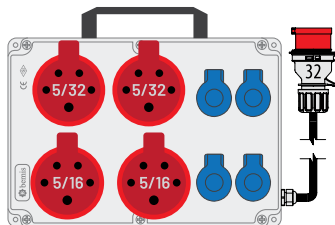
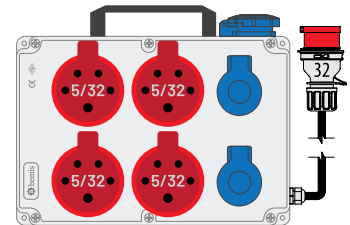
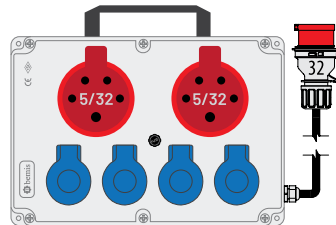
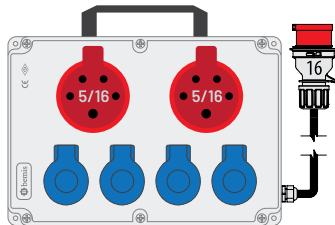
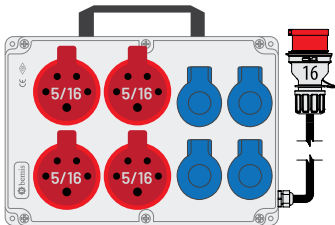
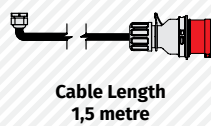



Thermal Fuse



PG16 / PG21 Rekor

ABS

IP44



1

# Metal Support Handled Powerbox 210x300x90mm

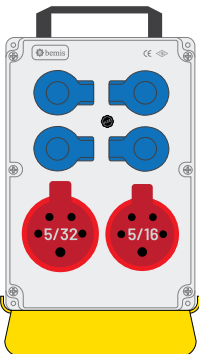

BKP-8296-4025

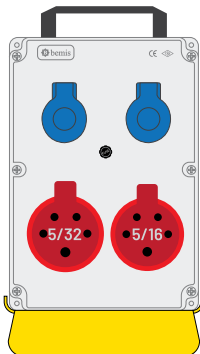

BKP-8296-2025

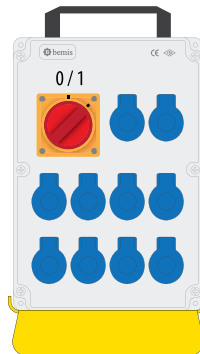

BKP-8250-5022

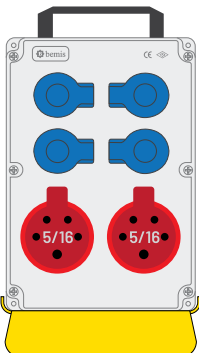

BKP-8226-4021

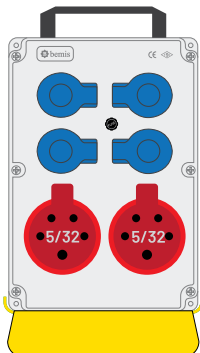

BKP-8229-4025

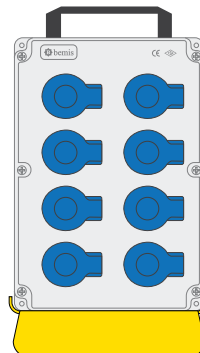

BKP-8280-0021

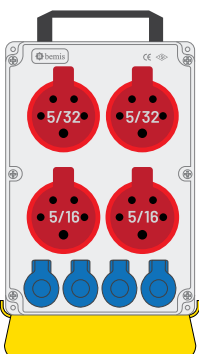

BKP-8229-26421

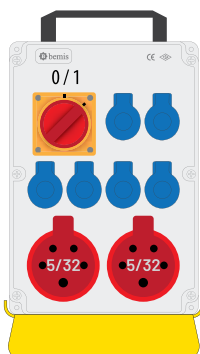

BKP-8229-6024

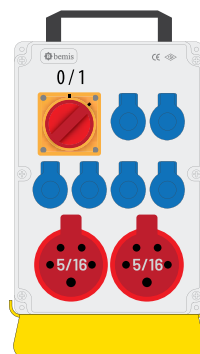

BKP-8226-6024



## Powerbox with metal Stand 210x300x90mm



Thermal Fuse



PG16 / PG21  
Rekor



ABS



IP44



1

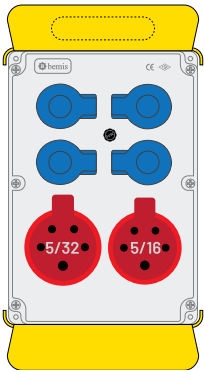

BKP-8296-4020

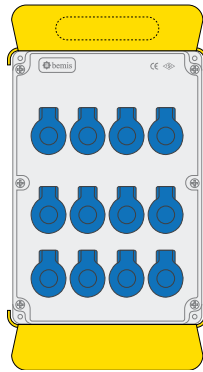

BKP-8260-6016

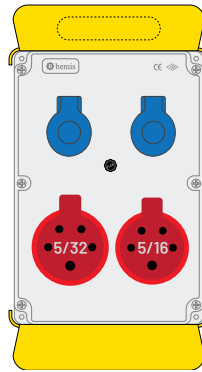

BKP-8296-2020

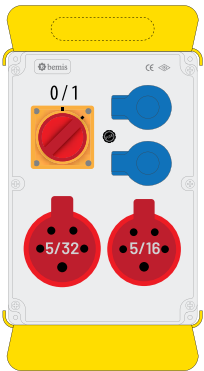

BKP-8296-2017

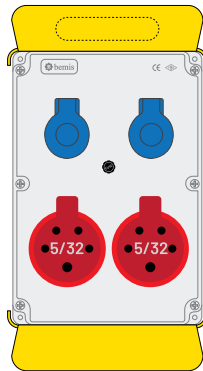

BKP-8229-2020

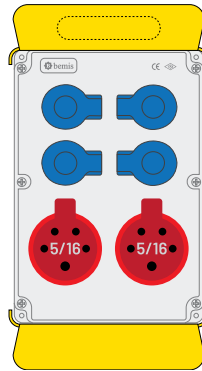

BKP-8226-4016

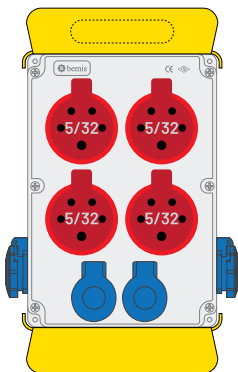

BKP-8249-4016



# POWERBOX

## Powerbox With Corrugated Bar 210x300x90mm



Cable Length  
1,5 metre



Thermal Fuse



PG16 / PG21  
Rekor



ABS



IP44



1

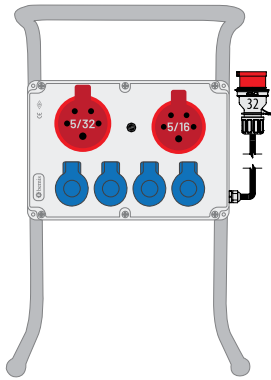

BKP38296-4011

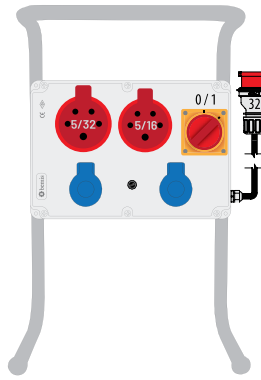

BKP38296-2013

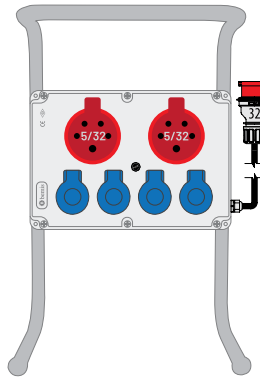

BKP38229-4011

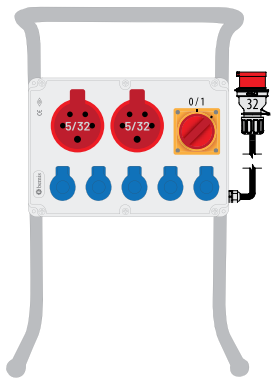

BKP38229-5015

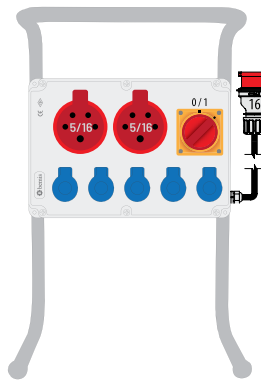

BKP78226-5015

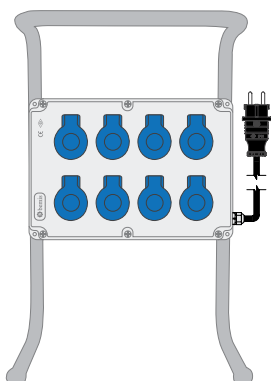

BKP98280-0012

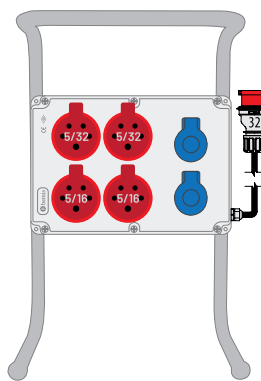

BKP38229-26212



## InterLock®

16A.



32A.



63A.



**CEE Norm  
Interlock Socket  
380V. 3P+E+N (ABS)**

Product Code	Descriptions	IP	Box	Pack
BC1-1403-7540	3/16A. 90° Angled Surface Socket	IP67	1	0
BC1-1403-7560	3/16A. Straight Surface Mounted Socket	IP67	1	0
BC1-1504-7540	4/16A. 90° Angled Surface Socket	IP67	1	0
BC1-1504-7560	4/16A. Straight Surface Mounted Socket	IP67	1	0
BC1-1505-7540	5/16A. 90° Angled Surface Socket	IP67	1	0
BC1-1505-7560	5/16A. Straight Surface Mounted Socket	IP67	1	0
BC1-3403-7540	3/32A. 90° Angled Surface Socket	IP67	1	0
BC1-3504-7540	4/32A. 90° Angled Surface Socket	IP67	1	0
BC1-3505-7540	5/32A. 90° Angled Surface Socket	IP67	1	0
BC1-4504-7540	4/63A. 90° Angled Surface Socket	IP67	1	0
BC1-4505-7540	5/63A. 90° Angled Surface Socket	IP67	1	0



**Safety Socket with Misuse Prevention and Device Protection**

**International Standards:** IEC 309-1, IEC 309-2

**European Standards:** EN 60 309-1, EN 60 309-2

**Flame & Fire Resistance:** Withstands temperatures exceeding 850°C in the glowing wire test

**Mechanical Interlock Switch:** Activates only when a plug is inserted

**Safety Lock Mechanism:** The plug can only be removed when the switch is in the "Off" position

**Switch Compatibility:** Compliant with IEC 60947, suitable for AC 21, AC 22, and AC 23 applications

**Protection Ratings:** IP67 (Ingress Protection) & IK8 (Mechanical Impact Protection)





## General Areas of Use of High Current Products

### Primary Application Areas

Ports & Container Storage  
Ships & Shipyards  
Mobile & Heavy Loads  
Construction Sites  
Tunnels & Mining Areas  
Quarries & Open-Pit Mines  
Railway Systems  
Industrial Facilities  
Events & Large-Scale Organizations  
Industrial Furnace Facilities  
Defense Industry

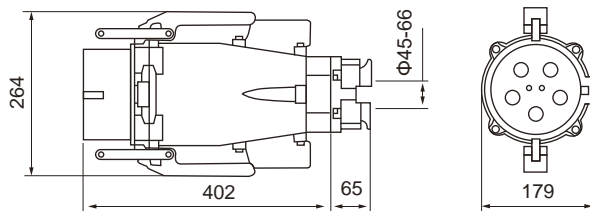

## High Amperage

200A. - 250A - 350A. - 400A.

### Key Characteristics

**High Current Capacity:** Available in 200A, 250A, 350A, and 400A for diverse applications.

**High Voltage Endurance:** Compatible with 380V-415V AC, 50/60 Hz systems.

**Multiple Connection Options:** Configurations of 4 contacts (3P+E) and 5 contacts (3P+N+E).

**Pilot Contact Support:** Includes 2 pilot contacts for enhanced safety and control.

**IP67 Protection Rating:** Ensures complete sealing against harsh environments.

**Silver-Plated Contacts:** Provides better conductivity and extended durability.

**Easy Installation & Removal:** Auxiliary handles enable quick and effortless use.

**Replaceable Contact Parts:** 250A and 400A models allow easy front-side contact replacement.

**Advanced Safety Features:** Includes circuit breaker, electrical interlock, mechanical interlock, and earth leakage protection.

**Full Compliance with Standards:** Manufactured according to IEC EN 60309-1 / VDE 0623 and IEC 60309-2 coding systems.

Body	Nominal Current (A)	Rated Current (A)	Operating Temperature	Cable Cross-Section (mm <sup>2</sup> )
Plastic	200	200	- 40 °C / +100 °C	35 - 150
Plastic	250	250	- 40 °C / +100 °C	35 - 150
Aluminum	350	350	- 40 °C / +100 °C	70 - 240
Aluminum	400	400	- 40 °C / +100 °C	70 - 240



## 4x200A. (3P+E) 380V.

Product Code	Descriptions	IP	Box	Pack
BC1-7504-7011	4/200A Straight Plug	IP67	1	0
BC1-7504-7022	4/200A Angled Plug	IP67	1	0
BC1-7504-7312	4/200A Connector Socket	IP67	1	0
BC1-7504-7413	4/200A Panel Mounted Socket	IP67	1	0
BC1-7504-7114	4/200A Panel Mounted Plug	IP67	1	0
BC1-7504-7540	4/200A 90° Angled Surface Socket	IP67	1	0

## 5x200A. (3P+E+N) 380V.

Product Code	Descriptions	IP	Box	Pack
BC1-7505-7011	5/200A Straight Plug	IP67	1	0
BC1-7505-7022	5/200A Angled Plug	IP67	1	0
BC1-7505-7312	5/200A Connector Socket	IP67	1	0
BC1-7505-7413	5/200A Panel Mounted Socket	IP67	1	0
BC1-7505-7114	5/200A Panel Mounted Plug	IP67	1	0
BC1-7505-7540	5/200A 90° Angled Surface Socket	IP67	1	0

# 250 Amper Series

## 4x250A. (3P+E) 380V.

Product Code	Descriptions	IP	Box	Pack
BC1-1014-7011	4/250A Straight Plug	IP67	1	0
BC1-1014-7022	4/250A Angled Plug	IP67	1	0
BC1-1014-7312	4/250A Connector Socket	IP67	1	0
BC1-1014-7413	4/250A Panel Mounted Socket	IP67	1	0
BC1-1014-7114	4/250A Panel Mounted Plug	IP67	1	0
BC1-1014-7540	4/250A 90° Angled Surface Socket	IP67	1	0

## 5x250A. (3P+E+N) 380V.

Product Code	Descriptions	IP	Box	Pack
BC1-1015-7011	5/250A Straight Plug	IP67	1	0
BC1-1015-7022	5/250A Angled Plug	IP67	1	0
BC1-1015-7312	5/250A Connector Socket	IP67	1	0
BC1-1015-7413	5/250A Panel Mounted Socket	IP67	1	0
BC1-1015-7114	5/250A Panel Mounted Plug	IP67	1	0
BC1-1015-7540	5/250A 90° Angled Surface Socket	IP67	1	0



# 350 Amper Series

## 4x350A. (3P+E) 380V.

Brand New  
Brand New  
Brand New  
Brand New  
Brand New  
Brand New

Product Code	Descriptions	IP	Box	Pack
BC1-1114-7011	4/350A Straight Plug	IP67	1	0
BC1-1114-7022	4/350A Angled Plug	IP67	1	0
BC1-1114-7312	4/350A Connector Socket	IP67	1	0
BC1-1114-7413	4/350A Panel Mounted Socket	IP67	1	0
BC1-1114-7114	4/350A Panel Mounted Plug	IP67	1	0
BC1-1114-7540	4/350A 90° Angled Surface Socket	IP67	1	0

## 5x350A. (3P+E+N) 380V.

Brand New  
Brand New  
Brand New  
Brand New  
Brand New  
Brand New

Product Code	Descriptions	IP	Box	Pack
BC1-1115-7011	5/350A Straight Plug	IP67	1	0
BC1-1115-7022	5/350A Angled Plug	IP67	1	0
BC1-1115-7312	5/350A Connector Socket	IP67	1	0
BC1-1115-7413	5/350A Panel Mounted Socket	IP67	1	0
BC1-1115-7114	5/350A Panel Mounted Plug	IP67	1	0
BC1-1115-7540	5/350A 90° Angled Surface Socket	IP67	1	0

# 400 Amper Series

## 4x400A. (3P+E) 380V.

Brand New  
Brand New

Product Code	Descriptions	IP	Box	Pack
BC1-9504-7011	4/400A Straight Plug	IP67	1	0
BC1-9504-7022	4/400A Angled Plug	IP67	1	0
BC1-9504-7312	4/400A Connector Socket	IP67	1	0
BC1-9504-7413	4/400A Panel Mounted Socket	IP67	1	0
BC1-9504-7114	4/400A Panel Mounted Plug	IP67	1	0
BC1-9504-7540	4/400A 90° Angled Surface Socket	IP67	1	0

## 5x400A. (3P+E+N) 380V.

Brand New  
Brand New  
Brand New

Product Code	Descriptions	IP	Box	Pack
BC1-9505-7011	5/400A Straight Plug	IP67	1	0
BC1-9505-7022	5/400A Angled Plug	IP67	1	0
BC1-9505-7312	5/400A Connector Socket	IP67	1	0
BC1-9505-7413	5/400A Panel Mounted Socket	IP67	1	0
BC1-9505-7114	5/400A Panel Mounted Plug	IP67	1	0
BC1-9505-7540	5/400A 90° Angled Surface Socket	IP67	1	0



# Lighting

## Transformer and Hand Lamp

### Transformer and Hand Lamp





## Lighting

*Transformer and Hand Lamp*



Product Code	Descriptions	IP	Box	Pack
BA1-1001-0001	Key Portable Hand Lamp	IP20	1	12
BA1-2001-0001	Keyless Portable Hand Lamp	IP20	1	12
BA1-1001-1031	Key 7,5 mt. Cabled Portable Hand Lamp	IP20	1	6
BA1-2001-1031	Keyless 7,5 mt. Cabled Portable Hand Lamp	IP20	1	6
BA1-1001-1021	Key 7,5 mt. Cabled Portable Hand Lamp	IP20	1	6

Product Code	Descriptions	IP	Box	Pack
BA2-0110-0121	24V. 100W. Transformer Portable Hand Lamp	IP20	1	0
BA2-0210-0121	24V. 200W. Transformer	IP20	1	0
BA2-0111-1121	24V. 100W. Transformer Portable Hand Lamp	IP20	1	0
BA2-0211-1121	24V. 200W. Transformer	IP20	1	0



Key Portable Hand Lamp  
BA1-1001-0001



Keyless Portable Hand Lamp  
BA1-2001-0001



Key 7,5mt. Cabled  
Portable Hand Lamp  
BA1-1001-1031



Keyless 7,5mt. Cabled  
Portable Hand Lamp  
BA1-2001-1031



Key 7,5mt. 2x1mm Cabled  
Portable Hand Lamp 24V. Plug  
BA1-1001-1021



24V. 100W. Transformer  
Portable Hand Lamp  
BA2-0111-1121



24V. 100W. Transformer  
BA2-0110-0121



24V. 200W. Transformer  
Portable Hand Lamp  
BA2-0211-1121



24V. 200W. Transformer  
BA2-0210-0121





**SGS Construction Check Report**

Task list results:

	Survey 1	Survey 2	Survey 3
Are you a contractor?	Yes	Yes	Yes
Are you a subcontractor?	Yes	Yes	Yes
Do you have a contract?	Yes	Yes	Yes
Do you have a contract for the work to be carried out?	Yes	Yes	Yes
Do you have a contract for the work to be carried out (including any sub-contractors)?	Yes	Yes	Yes
Do you have a contract for the work to be carried out (including any sub-contractors) (including any sub-contractors)?	Yes	Yes	Yes
Do you have a contract for the work to be carried out (including any sub-contractors) (including any sub-contractors) (including any sub-contractors)?	Yes	Yes	Yes
Do you have a contract for the work to be carried out (including any sub-contractors) (including any sub-contractors) (including any sub-contractors) (including any sub-contractors)?	Yes	Yes	Yes
Do you have a contract for the work to be carried out (including any sub-contractors) (including any sub-contractors) (including any sub-contractors) (including any sub-contractors) (including any sub-contractors)?	Yes	Yes	Yes

Signature and name:

Survey 1	Survey 2	Survey 3
Signature	Signature	Signature
Name	Name	Name
Company	Company	Company
Date	Date	Date

**SGS Construction Check Report**

Signature and name:

Survey 1	Survey 2	Survey 3
Signature	Signature	Signature
Name	Name	Name
Company	Company	Company
Date	Date	Date



**Combinations**  
V5 - V7 - V10 - V12 - V15 - V17 - V20 - V26

**Halogen Free Certificate**



Product Code	Descriptions	IP	Box	Pack
BD1-2000-0000	V Automat Rail and 1 Terminal	IP44	1	12
BD1-2101-0000	Empty Box 1 Pc. Hole	IP44	1	12
BD1-2101-2020	Front 1 Pc.Hole 1/16A 220V 2 Pcs. Side	IP44	1	12
BD1-2103-0000	1/16A. 220V. 1 Pc. Panel Mounted Socket Front	IP44	1	12
BD1-2103-2020	1/16A. 220V. 1 Pc. Panel Mounted Socket Front-1/16A. 220V. 2 Pcs. Side	IP44	1	12
BD1-2105-0000	3/25A. 380V. 1 Pc. Front	IP44	1	12
BD1-2105-1020	3/25A. 380V. 1 Pc. Front 1/16A. 220V. 1 Pc. Side	IP44	1	12
BD1-2105-2020	3/25A. 380V. 1 Pc. Front 1/16A. 220V. 2 Pcs. Side	IP44	1	12
BD1-2112-0000	4/16A. 380V. 1 Pc. Front	IP44	1	12
BD1-2112-2020	4/16A. 380V. 1 Pc. Front. 1/16A. 220V. 2 Pcs. Side	IP44	1	12
BD1-2118-0000	5/16A. 380V. 1 Pc. Front	IP44	1	12
BD1-2118-1020	5/16A. 380V. 1 Pc. Front - 1/16A. 220V. 1 Pc. Side	IP44	1	12
BD1-2118-2020	5/16A. 380V. 1 Pc. Front 1/16A. 220V. 2 Pcs. Side	IP44	1	12
BD1-2123-2020	3/32A. 220V. 1 Pc. Front - 1/16A. 220V. 2 Pcs. Side	IP44	1	12
BD1-2128-0000	4/32A. 380V. 1 Pc. Front	IP44	1	12
BD1-2128-2020	4/32A. 380V. 1 Pc. Front - 1/16A. 220V. 2 Pcs. Side	IP44	1	12
BD1-2134-0000	5/32A. 380V. 1 Pc. Front	IP44	1	12
BD1-2134-1020	5/32A. 380V. 1 Pc. Front - 1/16A. 220V. 1 Pc. Side	IP44	1	12
BD1-2134-2020	5/32A. 380V. 1 Pc. Front 1/16A. 220V. 2 Pcs. Side	IP44	1	12
BD1-2202-0000	1/16A. 220V. 2 Pcs. Front Socket	IP44	1	12
BD1-2202-2020	1/16A. 220V. 2 Pcs. Front 1/16A. 220V. 2 Pcs. Side	IP44	1	12
BD1-6000-0000	V Automat Rail and 1 Terminal	IP66	1	12
BD1-6114-0000	5/16A. 380V. 1 Pc. Front	IP66	1	12
BD1-6114-2020	5/16A. 380V. IP67 1 Pc. Front 1/16A. 220V. IP68 2 Pcs. Side	IP66	1	12
BD1-6124-0000	4/32A. 380V. 1 Pc. Front	IP66	1	12
BD1-6130-0000	5/32A. 380V. 1 Pc. Front	IP66	1	12
BD1-6130-2020	5/32A. 380V. IP67 1 Pc. Front 1/16A. 220V. IP68 2 Pcs. Side	IP66	1	12

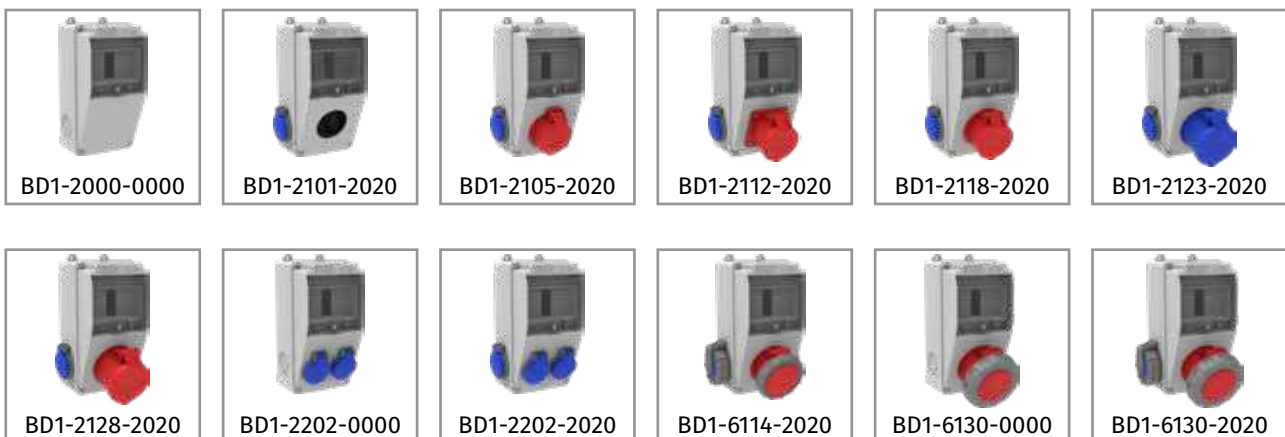

**5 FUSE CAPACITY**

Product Code	Descriptions	IP	Box	Pack
BH1-2000-0000	V Automat Rail and 1 Terminal	IP44	1	12
BH1-2101-0000	Empty Box 1 Pc. Hole	IP44	1	12
BH1-2101-2020	Front 1 Pc.Hole 1/16A 220V 2 Pcs. Side	IP44	1	12
BH1-2103-0000	1/16A. 220V. 1 Pc. Panel Mounted Socket Front	IP44	1	12
BH1-2103-2020	1/16A. 220V. 1 Pc. Panel Mounted Socket Front-1/16A. 220V. 2 Pcs. Side	IP44	1	12
BH1-2105-0000	3/25A. 380V. 1 Pc. Front	IP44	1	12
BH1-2105-1020	3/25A. 380V. 1 Pc. Front 1/16A. 220V. 1 Pc. Side	IP44	1	12
BH1-2105-2020	3/25A. 380V. 1 Pc. Front 1/16A. 220V. 2 Pcs. Side	IP44	1	12
BH1-2112-0000	4/16A. 380V. 1 Pc. Front	IP44	1	12
BH1-2112-2020	4/16A. 380V. 1 Pc. Front. 1/16A. 220V. 2 Pcs. Side	IP44	1	12
BH1-2118-0000	5/16A. 380V. 1 Pc. Front	IP44	1	12
BH1-2118-1020	5/16A. 380V. 1 Pc. Front - 1/16A. 220V. 1 Pc. Side	IP44	1	12
BH1-2118-2020	5/16A. 380V. 1 Pc. Front 1/16A. 220V. 2 Pcs. Side	IP44	1	12
BH1-2123-2020	3/32A. 220V. 1 Pc. Front - 1/16A. 220V. 2 Pcs. Side	IP44	1	12
BH1-2128-0000	4/32A. 380V. 1 Pc. Front	IP44	1	12
BH1-2128-2020	4/32A. 380V. 1 Pc. Front - 1/16A. 220V. 2 Pcs. Side	IP44	1	12
BH1-2134-0000	5/32A. 380V. 1 Pc. Front	IP44	1	12
BH1-2134-1020	5/32A. 380V. 1 Pc. Front - 1/16A. 220V. 1 Pc. Side	IP44	1	12
BH1-2134-2020	5/32A. 380V. 1 Pc. Front 1/16A. 220V. 2 Pcs. Side	IP44	1	12
BH1-2202-0000	1/16A. 220V. 2 Pcs. Front Socket	IP44	1	12
BH1-2202-2020	1/16A. 220V. 2 Pcs. Front 1/16A. 220V. 2 Pcs. Side	IP44	1	12
BH1-6000-0000	V Automat Rail and 1 Terminal	IP66	1	12
BH1-6114-0000	5/16A. 380V. 1 Pc. Front	IP66	1	12
BH1-6114-2020	5/16A. 380V. IP67 1 Pc. Front 1/16A. 220V. IP68 2 Pcs. Side	IP66	1	12
BH1-6124-0000	4/32A. 380V. 1 Pc. Front	IP66	1	12
BH1-6130-0000	5/32A. 380V. 1 Pc. Front	IP66	1	12
BH1-6130-2020	5/32A. 380V. IP67 1 Pc. Front 1/16A. 220V. IP68 2 Pcs. Side	IP66	1	12

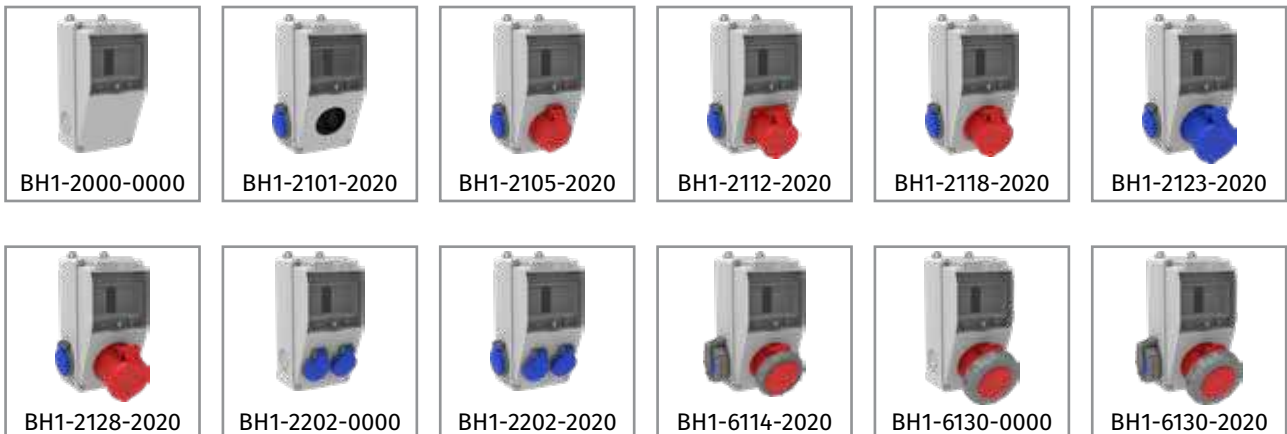

Product Code	Descriptions	IP	Box	Pack
BD5-2000-0000	V Automat Rail and 1 Terminal	IP44	1	12
BD5-2101-0000	Empty Box 1 Pc. Hole	IP44	1	12
BD5-2101-2020	Front 1 Pc. Hole - Side 2 Pcs. 1/16A. 220V.	IP44	1	12
BD5-2103-0000	1/16A. 220V. 1 Pc. Panel Mounted Socket Front	IP44	1	12
BD5-2103-2020	1/16A. 220V. 1 Pc. Panel Mounted Socket Front - 1/16A. 220V. 2 Pcs. Side	IP44	1	12
BD5-2105-0000	3/25A. 380V. 1 Pc. Front	IP44	1	12
BD5-2105-2020	Front 1 Pc. 3/25A. 380V. Side 2 Pcs. 1/16A. 220V.	IP44	1	12
BD5-2105-4020	3/25A. 380V. 1 Pc. Front - 1/16A. 220V. 2 Pcs. Side - 1/16A. 220V. 2 Pcs. Bottom	IP44	1	12
BD5-2112-0000	4/16A. 380V. 1 Pc. Front	IP44	1	12
BD5-2112-2020	4/16A. 380V. 1 Pc. Front - 1/16A. 220V. 2 Pcs. Side	IP44	1	12
BD5-2112-4020	4/16A. 380V. 1 Pc. Front - 1/16A. 220V. 2 Pcs. Side - 1/16A. 220V. 2 Pcs. Bottom	IP44	1	12
BD5-2118-0000	5/16A. 380V. 1 Pc. Front	IP44	1	12
BD5-2118-2020	Front 1 Pc. 5/16A. 380V. Side 2 Pcs. 1/16A. 220V.	IP44	1	12
BD5-2118-4020	5/16A. 380V. 1 Pc. Front - 1/16A. 220V. 2 Pcs. Side - 1/16A. 220V. 2 Pcs. Bottom	IP44	1	12
BD5-2123-2020	3/32A. 220V. 1 Pc. Front - 1/16A. 220V. 2 Pcs. Side	IP44	1	12
BD5-2128-0000	4/32A. 380V. 1 Pc. Front	IP44	1	12
BD5-2128-2020	4/32A. 380V. 1 Pc. Front - 1/16A. 220V. 2 Pcs. Side	IP44	1	12
BD5-2128-4020	4/32A. 380V. 1 Pc. Front - 1/16A. 220V. 2 Pcs. Side - 1/16A. 220V. 2 Pcs. Bottom	IP44	1	12
BD5-2134-0000	5/32A. 380V. 1 Pc. Front	IP44	1	12
BD5-2134-2020	Front 1 Pc. 5/32A. 380V. Side 2 Pcs. 1/16A. 220V.	IP44	1	12
BD5-2134-4020	5/32A. 380V. 1 Pc. Front - 1/16A. 220V. 2 Pcs. Side - 1/16A. 220V. 2 Pcs. Bottom	IP44	1	12
BD5-2144-2020	4/63A. 380V. 1 Pc. Front - 1/16A. 220V. 2 Pcs. Side	IP44	1	12
BD5-2202-0000	1/16A. 220V. 2 Pcs. Front	IP44	1	12
BD5-2202-2020	1/16A. 220V. 2 Pcs. Front - 1/16A. 220V. 2 Pcs. Side	IP44	1	12
BD5-6000-0000	V Automat Rail and 1 Terminal	IP66	1	12
BD5-6102-2020	1/16A. 220V. 1 Pc. Front - 1/16A. 220V. 2 Pcs. Side	IP66	1	12
BD5-6114-0000	5/16A. 380V. 1 Pc. Front	IP66	1	12
BD5-6114-2020	Front 1 Pc. 5/16A. 380V. Side 2 Pcs. 1/16A. 220V.	IP66	1	12
BD5-6124-0000	4/32A. 380V. 1 Pc. Front	IP66	1	12
BD5-6124-2020	4/32A. 380V. 1 Pc. Front - 1/16A. 220V. 2 Pcs. Side	IP66	1	12
BD5-6130-0000	5/32A. 380V. 1 Pc. Front	IP66	1	12
BD5-6130-2020	Front 1 Pc. 5/32A. 380V. Side 2 Pcs. 1/16A. 220V.	IP66	1	12
BD5-6140-2020	4/63A. 380V. 1 Pc. Front - 1/16A. 220V. 2 Pcs. Side	IP66	1	12



**V7 Halogen Free COMBINATIONS  
(155x255x138)**



**7 FUSE CAPACITY**

Product Code	Descriptions	IP	Box	Pack
BH5-2000-0000	V Automat Rail and 1 Terminal	IP44	1	12
BH5-2101-0000	Empty Box 1 Pc. Hole	IP44	1	12
BH5-2101-2020	Front 1 Pc. Hole - Side 2 Pcs. 1/16A. 220V.	IP44	1	12
BH5-2103-0000	1/16A. 220V. 1 Pc. Panel Mounted Socket Front	IP44	1	12
BH5-2103-2020	1/16A. 220V. 1 Pc. Panel Mounted Socket Front - 1/16A. 220V. 2 Pcs. Side	IP44	1	12
BH5-2105-0000	3/25A. 380V. 1 Pc. Front	IP44	1	12
BH5-2105-2020	Front 1 Pc. 3/25A. 380V. Side 2 Pcs. 1/16A. 220V.	IP44	1	12
BH5-2105-4020	3/25A. 380V. 1 Pc. Front - 1/16A. 220V. 2 Pcs. Side - 1/16A. 220V. 2 Pcs. Bottom	IP44	1	12
BH5-2112-0000	4/16A. 380V. 1 Pc. Front	IP44	1	12
BH5-2112-2020	4/16A. 380V. 1 Pc. Front - 1/16A. 220V. 2 Pcs. Side	IP44	1	12
BH5-2112-4020	4/16A. 380V. 1 Pc. Front - 1/16A. 220V. 2 Pcs. Side - 1/16A. 220V. 2 Pcs. Bottom	IP44	1	12
BH5-2118-0000	5/16A. 380V. 1 Pc. Front	IP44	1	12
BH5-2118-2020	Front 1 Pc. 5/16A. 380V. Side 2 Pcs. 1/16A. 220V.	IP44	1	12
BH5-2118-4020	5/16A. 380V. 1 Pc. Front - 1/16A. 220V. 2 Pcs. Side - 1/16A. 220V. 2 Pcs. Bottom	IP44	1	12
BH5-2123-2020	3/32A. 220V. 1 Pc. Front - 1/16A. 220V. 2 Pcs. Side	IP44	1	12
BH5-2128-0000	4/32A. 380V. 1 Pc. Front	IP44	1	12
BH5-2128-2020	4/32A. 380V. 1 Pc. Front - 1/16A. 220V. 2 Pcs. Side	IP44	1	12
BH5-2128-4020	4/32A. 380V. 1 Pc. Front - 1/16A. 220V. 2 Pcs. Side - 1/16A. 220V. 2 Pcs. Bottom	IP44	1	12
BH5-2134-0000	5/32A. 380V. 1 Pc. Front	IP44	1	12
BH5-2134-2020	Front 1 Pc. 5/32A. 380V. Side 2 Pcs. 1/16A. 220V.	IP44	1	12
BH5-2134-4020	5/32A. 380V. 1 Pc. Front - 1/16A. 220V. 2 Pcs. Side - 1/16A. 220V. 2 Pcs. Bottom	IP44	1	12
BH5-2144-2020	4/63A. 380V. 1 Pc. Front - 1/16A. 220V. 2 Pcs. Side	IP44	1	12
BH5-2202-0000	1/16A. 220V. 2 Pcs. Front	IP44	1	12
BH5-2202-2020	1/16A. 220V. 2 Pcs. Front - 1/16A. 220V. 2 Pcs. Side	IP44	1	12
BH5-6000-0000	V Automat Rail and 1 Terminal	IP66	1	12
BH5-6102-2020	1/16A. 220V. 1 Pc. Front - 1/16A. 220V. 2 Pcs. Side	IP66	1	12
BH5-6114-0000	5/16A. 380V. 1 Pc. Front	IP66	1	12
BH5-6114-2020	Front 1 Pc. 5/16A. 380V. Side 2 Pcs. 1/16A. 220V.	IP66	1	12
BH5-6124-0000	4/32A. 380V. 1 Pc. Front	IP66	1	12
BH5-6124-2020	4/32A. 380V. 1 Pc. Front - 1/16A. 220V. 2 Pcs. Side	IP66	1	12
BH5-6130-0000	5/32A. 380V. 1 Pc. Front	IP66	1	12
BH5-6130-2020	Front 1 Pc. 5/32A. 380V. Side 2 Pcs. 1/16A. 220V.	IP66	1	12
BH5-6140-2020	4/63A. 380V. 1 Pc. Front - 1/16A. 220V. 2 Pcs. Side	IP66	1	12

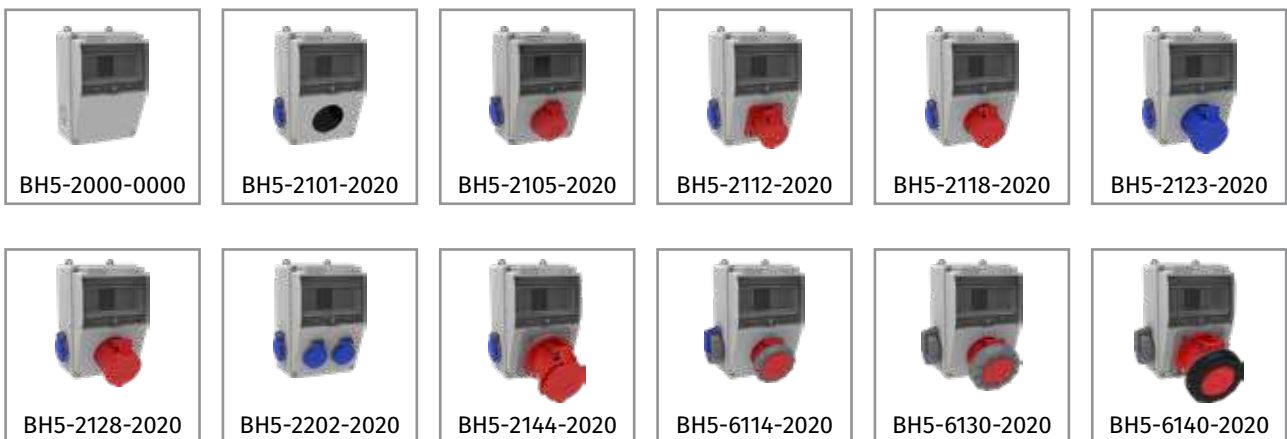

Product Code	Descriptions	IP	Box	Pack
BD2-2000-0000	V Automat Rail and 2 Terminal	IP44	1	6
BD2-2118-2020	5/16A. 380V. 1 Pc. Front - 1/16A. 220V. 2 Pcs. Front	IP44	1	6
BD2-2118-2022	5/16A. 380V. 1 Pc. Front - 1/16A. 220V. 2 Pcs. Front - 1/16A. 220V. 2 Pcs. Side	IP44	1	6
BD2-2134-1030	5/32A. 380V. 1 Pc. Front - 1/16A. 220V. 1 Pc. Panel Mounted Socket Front	IP44	1	6
BD2-2134-1182	5/32A. 380V. 1 Pc. Front - 5/16A. 380V. 1 Pc. Front - 1/16A. 220V. 2 Pcs. Side	IP44	1	6
BD2-2134-1282	5/32A. 380V. 1 Pc. Front - 4/32A. 380V. 1 Pc. Front - 1/16A. 220V. 2 Pcs. Side	IP44	1	6
BD2-2134-2020	5/32A. 380V. 1 Pc. Front - 1/16A. 220V. 2 Pcs. Front	IP44	1	6
BD2-2149-2020	5/63A. 380V. 1 Pc. Front - 1/16A. 220V. 2 Pcs. Front	IP44	1	6
BD2-2201-0000	Empty Box Front 2 Pcs. Hole	IP44	1	6
BD2-2201-2010	Empty Box Front 2 Pcs. Hole - Side 2 Pcs. Hole	IP44	1	6
BD2-2201-2020	Front 2 Pcs. Hole Side 2 Pcs. 1/16A. 220V.	IP44	1	6
BD2-2205-0000	3/25A. 380V. 2 Pcs. Front	IP44	1	6
BD2-2205-2020	Front 2 Pcs. 3/25A. 380V. Side 2 Pcs. 1/16A. 220V.	IP44	1	6
BD2-2205-4020	3/25A. 380V. 2 Pcs. Front - 1/16A. 220V. 4 Pcs. Side	IP44	1	6
BD2-2212-2020	4/16A. 380V. 2 Pcs. Front - 1/16A. 220V. 2 Pcs. Side	IP44	1	6
BD2-2218-0000	5/16A. 380V. 2 Pcs. Side	IP44	1	6
BD2-2218-2020	Front 2 Pcs. 5/16A. 380V. Side 2 Pcs. 1/16A. 220V.	IP44	1	6
BD2-2218-4020	5/16A. 380V. 2 Pcs. Front - 1/16A. 220V. 4 Pcs. Side	IP44	1	6
BD2-2228-0000	4/32A. 380V. 2 Pcs. Front	IP44	1	6
BD2-2228-2020	Front 2 Pcs. 4/32A. 380V. Side 2 Pcs. 1/16A. 220V.	IP44	1	6
BD2-2234-0000	5/32A. 380V. 2 Pcs. Front	IP44	1	6
BD2-2234-2020	Front 2 Pcs. 5/32A. 380V. Side 2 Pcs. 1/16A. 220V.	IP44	1	6
BD2-2234-4020	5/32A. 380V. 2 Pcs. Front - 1/16A. 220V. 4 Pcs. Side	IP44	1	6
BD2-2402-0000	1/16A. 220V. 4 Pcs. Panel Socket Front	IP44	1	6
BD2-2602-0000	1/16A. 220V. 6 Pcs. Panel Socket Front	IP44	1	6
BD2-6000-0000	V Automat Rail and 2 Terminal	IP66	1	6
BD2-6129-2020	5/32A. 45° Angled Panel Mounted Socket 1 Pc. Front. 1/16A IP68 2 Pcs. Side	IP66	1	6
BD2-6130-1142	5/32A. 380V. 1 Pc. Front 5/16A. 380V. 1 Pc. Front 1/16A. 220V. 2 Pcs. Side	IP66	1	6
BD2-6130-2020	5/32A. 380V. 1 Pc. Front 1/16A. 220V. 2 Pcs. Side	IP66	1	6
BD2-6208-0000	4/16A. 380V. 2 Pcs. Front	IP66	1	6
BD2-6214-2020	5/16A. 380V. IP67 2 Pcs. Front 1/16A. 220V. IP68 2 Pcs. Side	IP66	1	6
BD2-6224-0000	4/32A. 380V. 2 Pcs. Front	IP66	1	6
BD2-6230-0000	5/32A. 380V. 2 Pcs. Front	IP66	1	6
BD2-6230-2020	5/32A. 380V. 2 Pcs. Front 1/16A. 220V. IP68 2 Pcs. Side	IP66	1	6



**V10 Halogen Free COMBINATIONS  
(210x300x122)**



**10 FUSE CAPACITY**

Product Code	Descriptions	IP	Box	Pack
BH2-2000-0000	V Automat Rail and 2 Terminal	IP44	1	6
BH2-2118-2020	5/16A. 380V. 1 Pc. Front - 1/16A. 220V. 2 Pcs. Front	IP44	1	6
BH2-2118-2022	5/16A. 380V. 1 Pc. Front - 1/16A. 220V. 2 Pcs. Front - 1/16A. 220V. 2 Pcs. Side	IP44	1	6
BH2-2134-1030	5/32A. 380V. 1 Pc. Front - 1/16A. 220V. 1 Pc. Panel Mounted Socket Front	IP44	1	6
BH2-2134-1182	5/32A. 380V. 1 Pc. Front - 5/16A. 380V. 1 Pc. Front - 1/16A. 220V. 2 Pcs. Side	IP44	1	6
BH2-2134-1282	5/32A. 380V. 1 Pc. Front - 4/32A. 380V. 1 Pc. Front - 1/16A. 220V. 2 Pcs. Side	IP44	1	6
BH2-2134-2020	5/32A. 380V. 1 Pc. Front - 1/16A. 220V. 2 Pcs. Front	IP44	1	6
BH2-2149-2020	5/63A. 380V. 1 Pc. Front - 1/16A. 220V. 2 Pcs. Front	IP44	1	6
BH2-2201-0000	Empty Box Front 2 Pcs. Hole	IP44	1	6
BH2-2201-2010	Empty Box Front 2 Pcs. Hole - Side 2 Pcs. Hole	IP44	1	6
BH2-2201-2020	Front 2 Pcs. Hole Side 2 Pcs. 1/16A. 220V.	IP44	1	6
BH2-2205-0000	3/25A. 380V. 2 Pcs. Front	IP44	1	6
BH2-2205-2020	Front 2 Pcs. 3/25A. 380V. Side 2 Pcs. 1/16A. 220V.	IP44	1	6
BH2-2205-4020	3/25A. 380V. 2 Pcs. Front - 1/16A. 220V. 4 Pcs. Side	IP44	1	6
BH2-2212-2020	4/16A. 380V. 2 Pcs. Front - 1/16A. 220V. 2 Pcs. Side	IP44	1	6
BH2-2218-0000	5/16A. 380V. 2 Pcs. Side	IP44	1	6
BH2-2218-2020	Front 2 Pcs. 5/16A. 380V. Side 2 Pcs. 1/16A. 220V.	IP44	1	6
BH2-2218-4020	5/16A. 380V. 2 Pcs. Front - 1/16A. 220V. 4 Pcs. Side	IP44	1	6
BH2-2228-0000	4/32A. 380V. 2 Pcs. Front	IP44	1	6
BH2-2228-2020	Front 2 Pcs. 4/32A. 380V. Side 2 Pcs. 1/16A. 220V.	IP44	1	6
BH2-2234-0000	5/32A. 380V. 2 Pcs. Front	IP44	1	6
BH2-2234-2020	Front 2 Pcs. 5/32A. 380V. Side 2 Pcs. 1/16A. 220V.	IP44	1	6
BH2-2234-4020	5/32A. 380V. 2 Pcs. Front - 1/16A. 220V. 4 Pcs. Side	IP44	1	6
BH2-2402-0000	1/16A. 220V. 4 Pcs. Panel Socket Front	IP44	1	6
BH2-2602-0000	1/16A. 220V. 6 Pcs. Panel Socket Front	IP44	1	6
BH2-6000-0000	V Automat Rail and 2 Terminal	IP66	1	6
BH2-6129-2020	5/32A. 45° Angled Panel Mounted Socket 1 Pc. Front. 1/16A IP68 2 Pcs. Side	IP66	1	6
BH2-6130-1142	5/32A. 380V. 1 Pc. Front 5/16A. 380V. 1 Pc. Front 1/16A. 220V. 2 Pcs. Side	IP66	1	6
BH2-6130-2020	5/32A. 380V. 1 Pc. Front 1/16A. 220V. 2 Pcs. Side	IP66	1	6
BH2-6208-0000	4/16A. 380V. 2 Pcs. Front	IP66	1	6
BH2-6214-2020	5/16A. 380V. IP67 2 Pcs. Front 1/16A. 220V. IP68 2 Pcs. Side	IP66	1	6
BH2-6224-0000	4/32A. 380V. 2 Pcs. Front	IP66	1	6
BH2-6230-0000	5/32A. 380V. 2 Pcs. Front	IP66	1	6
BH2-6230-2020	5/32A. 380V. 2 Pcs. Front 1/16A. 220V. IP68 2 Pcs. Side	IP66	1	6

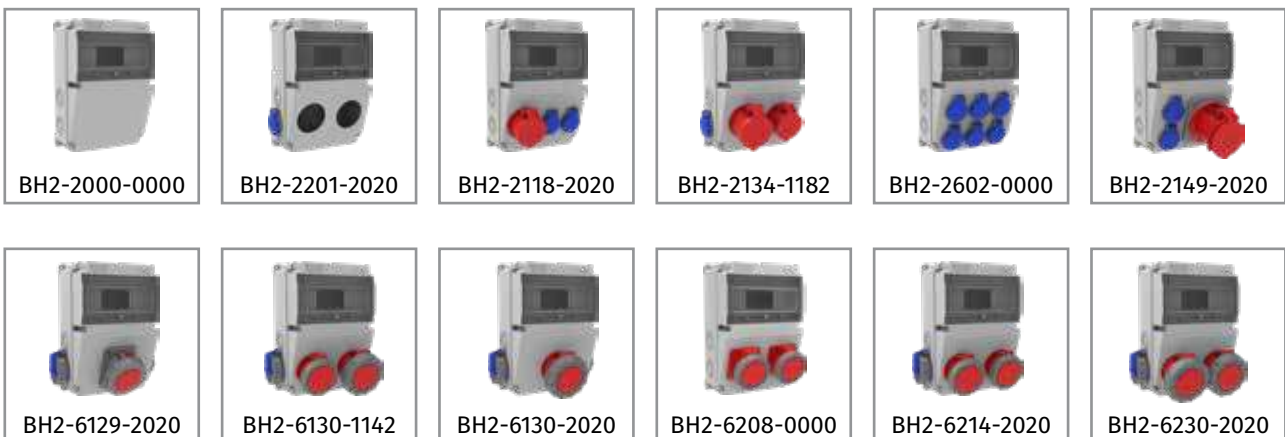

Product Code	Descriptions	IP	Box	Pack
BD6-2000-0000	V Automat Rail and 2 Terminal	IP44	1	6
BD6-2118-2020	5/16A. 380V. 1 Pc. Front - 1/16A. 220V. 2 Pcs. Front	IP44	1	6
BD6-2118-2022	5/16A. 380V. 1 Pc. Front - 1/16A. 220V. 2 Pcs. Front - 1/16A. 220V. 2 Pcs. Side	IP44	1	6
BD6-2134-1182	5/32A. 380V. 1 Pc. Front - 5/16A. 380V. 1 Pc. Front - 1/16A. 220V. 2 Pcs. Side	IP44	1	6
BD6-2134-1282	5/32A. 380V. 1 Pc. Front - 4/32A. 380V. 1 Pc. Front - 1/16A. 220V. 2 Pcs. Side	IP44	1	6
BD6-2134-2020	5/32A. 380V. 1 Pc. Front - 1/16A. 220V. 2 Pcs. Front	IP44	1	6
BD6-2149-2020	5/63A. 380V. 1 Pc. Front - 1/16A. 220V. 2 Pcs. Front	IP44	1	6
BD6-2201-0000	Empty Box Front 2 Pcs. Hole	IP44	1	6
BD6-2201-2010	Empty Box Front 2 Pcs. Hole - Side 2 Pcs. Hole	IP44	1	6
BD6-2201-2020	Front 2 Pcs. Hole 2 Pcs. Side 1/16A. 220V.	IP44	1	6
BD6-2205-0000	3/25A. 380V. 2 Pcs. Front	IP44	1	6
BD6-2205-2020	Front 2 Pcs. 3/25A. 380V. Side 2 Pcs. 1/16A. 220V.	IP44	1	6
BD6-2205-4020	3/25A. 380V. 2 Pcs. Front - 1/16A. 220V. 4 Pcs. Side	IP44	1	6
BD6-2212-2020	4/16A. 380V. 2 Pcs. Front - 1/16A. 220V. 2 Pcs. Side	IP44	1	6
BD6-2218-0000	5/16A. 380V. 2 Pcs. Side	IP44	1	6
BD6-2218-2020	Front 2 Pcs. 5/16A. 380V. Side 2 Pcs. 1/16A. 220V.	IP44	1	6
BD6-2228-0000	4/32A. 380V. 2 Pcs. Front	IP44	1	6
BD6-2228-2020	4/32A. 380V. 2 Pcs. Front - 1/16A. 220V. 2 Pcs. Side	IP44	1	6
BD6-2234-0000	5/32A. 380V. 2 Pcs. Front	IP44	1	6
BD6-2234-2020	Front 2 Pcs. 5/32A. 380V. Side 2 Pcs. 1/16A. 220V.	IP44	1	6
BD6-2234-4020	5/32A. 380V. 2 Pcs. Front - 1/16A. 220V. 4 Pcs. Side	IP44	1	6
BD6-2249-2020	5/63A. 380V. 2 Pcs. Front - 1/16A. 220V. 2 Pcs. Side	IP44	1	6
BD6-2802-4020	1/16A. 220V. 8 Pcs. Panel Socket Front - 1/16A. 220V. 4 Pcs. Panel Socket Side	IP44	1	6
BD6-6000-0000	V Automat Rail and 2 Terminal	IP66	1	6
BD6-6208-0000	4/16A. 380V. 2 Pcs. Front	IP66	1	6
BD6-6208-2020	4/16A. 380V. 2 Pcs. Front - 1/16A. 220V. 2 Pcs. Side	IP66	1	6
BD6-6214-2020	5/16A. 380V. 2 Pcs. Front - 1/16A. 220V. 2 Pcs. Side	IP66	1	6
BD6-6224-0000	4/32A. 380V. 2 Pcs. Front	IP66	1	6
BD6-6224-2020	4/32A. 380V. 2 Pcs. Front - 1/16A. 220V. 2 Pcs. Side	IP66	1	6
BD6-6230-0000	5/32A. 380V. 2 Pcs. Front	IP66	1	6
BD6-6230-2020	Front 2 Pcs. 5/32A. 380V. Side 2 Pcs. 1/16A. 220V. Screwless Panel Socket	IP66	1	6
BD6-6240-2020	4/63A. 380V. 2 Pcs. Front - 1/16A. 220V. 2 Pcs. Side	IP66	1	6
BD6-6245-2020	5/63A. 380V. 2 Pcs. Front - 1/16A. 220V. 2 Pcs. Side	IP66	1	6
BD6-6302-2020	1/16A. 220V. 3 Pcs. Front - 1/16A. 220V. 2 Pcs. Side	IP66	1	6





**V12 Halogen Free COMBINATIONS  
(245x325x138)**



**12 FUSE CAPACITY**

Product Code	Descriptions	IP	Box	Pack
BH6-2000-0000	V Automat Rail and 2 Terminal	IP44	1	6
BH6-2118-2020	5/16A. 380V. 1 Pc. Front - 1/16A. 220V. 2 Pcs. Front	IP44	1	6
BH6-2118-2022	5/16A. 380V. 1 Pc. Front - 1/16A. 220V. 2 Pcs. Front - 1/16A. 220V. 2 Pcs. Side	IP44	1	6
BH6-2134-1182	5/32A. 380V. 1 Pc. Front - 5/16A. 380V. 1 Pc. Front - 1/16A. 220V. 2 Pcs. Side	IP44	1	6
BH6-2134-1282	5/32A. 380V. 1 Pc. Front - 4/32A. 380V. 1 Pc. Front - 1/16A. 220V. 2 Pcs. Side	IP44	1	6
BH6-2134-2020	5/32A. 380V. 1 Pc. Front - 1/16A. 220V. 2 Pcs. Front	IP44	1	6
BH6-2149-2020	5/63A. 380V. 1 Pc. Front - 1/16A. 220V. 2 Pcs. Front	IP44	1	6
BH6-2201-0000	Empty Box Front 2 Pcs. Hole	IP44	1	6
BH6-2201-2010	Empty Box Front 2 Pcs. Hole - Side 2 Pcs. Hole	IP44	1	6
BH6-2201-2020	Front 2 Pcs. Hole 2 Pcs. Side 1/16A. 220V.	IP44	1	6
BH6-2205-0000	3/25A. 380V. 2 Pcs. Front	IP44	1	6
BH6-2205-2020	Front 2 Pcs. 3/25A. 380V. Side 2 Pcs. 1/16A. 220V.	IP44	1	6
BH6-2205-4020	3/25A. 380V. 2 Pcs. Front - 1/16A. 220V. 4 Pcs. Side	IP44	1	6
BH6-2212-2020	4/16A. 380V. 2 Pcs. Front - 1/16A. 220V. 2 Pcs. Side	IP44	1	6
BH6-2218-0000	5/16A. 380V. 2 Pcs. Side	IP44	1	6
BH6-2218-2020	Front 2 Pcs. 5/16A. 380V. Side 2 Pcs. 1/16A. 220V.	IP44	1	6
BH6-2228-0000	4/32A. 380V. 2 Pcs. Front	IP44	1	6
BH6-2228-2020	4/32A. 380V. 2 Pcs. Front - 1/16A. 220V. 2 Pcs. Side	IP44	1	6
BH6-2234-0000	5/32A. 380V. 2 Pcs. Front	IP44	1	6
BH6-2234-2020	Front 2 Pcs. 5/32A. 380V. Side 2 Pcs. 1/16A. 220V.	IP44	1	6
BH6-2234-4020	5/32A. 380V. 2 Pcs. Front - 1/16A. 220V. 4 Pcs. Side	IP44	1	6
BH6-2249-2020	5/63A. 380V. 2 Pcs. Front - 1/16A. 220V. 2 Pcs. Side	IP44	1	6
BH6-2802-4020	1/16A. 220V. 8 Pcs. Panel Socket Front - 1/16A. 220V. 4 Pcs. Panel Socket Side	IP44	1	6
BH6-6000-0000	V Automat Rail and 2 Terminal	IP66	1	6
BH6-6208-0000	4/16A. 380V. 2 Pcs. Front	IP66	1	6
BH6-6208-2020	4/16A. 380V. 2 Pcs. Front - 1/16A. 220V. 2 Pcs. Side	IP66	1	6
BH6-6214-2020	5/16A. 380V. 2 Pcs. Front - 1/16A. 220V. 2 Pcs. Side	IP66	1	6
BH6-6224-0000	4/32A. 380V. 2 Pcs. Front	IP66	1	6
BH6-6224-2020	4/32A. 380V. 2 Pcs. Front - 1/16A. 220V. 2 Pcs. Side	IP66	1	6
BH6-6230-0000	5/32A. 380V. 2 Pcs. Front	IP66	1	6
BH6-6230-2020	Front 2 Pcs. 5/32A. 380V. Side 2 Pcs. 1/16A. 220V. Screwless Panel Socket	IP66	1	6
BH6-6240-2020	4/63A. 380V. 2 Pcs. Front - 1/16A. 220V. 2 Pcs. Side	IP66	1	6
BH6-6245-2020	5/63A. 380V. 2 Pcs. Front - 1/16A. 220V. 2 Pcs. Side	IP66	1	6
BH6-6302-2020	1/16A. 220V. 3 Pcs. Front - 1/16A. 220V. 2 Pcs. Side	IP66	1	6



Product Code	Descriptions	IP	Box	Pack
BD9-2000-0000	V Automat Rail and 2 Terminal	IP44	1	3
BD9-2134-1182	5/32A. 380V. 1 Pc. Front-5/16A. 380V. 1 Pc. Front-1/16A. 220V. 2 Pcs. Side	IP44	1	3
BD9-2134-2120	5/32A. 380V. 1 Pc. Front-4/16A. 380V. 2 Pcs. Front	IP44	1	3
BD9-2144-1282	4/32A. 380V. 1 Pc. Front-4/63A. 380V. 1 Pc. Front-1/16A. 220V. 2 Pcs. Side	IP44	1	3
BD9-2149-2120	5/63A. 380V. 1 Pc. Front-4/16A. 380V. 2 Pcs. Front	IP44	1	3
BD9-2201-2010	Empty Box Front 2 Pcs. Hole - Side 2 Pcs. Hole	IP44	1	3
BD9-2205-1030	3/25A. 380V. 2 Pcs. Front-1/16A. 220V. 1 Pc. Front	IP44	1	3
BD9-2205-4020	3/25A. 380V. 2 Pcs. Front-1/16A. 220V. 4 Pcs. Side	IP44	1	3
BD9-2218-2020	Front 2 Pcs. 5/16A. 380V. Side 2 Pcs. 1/16A. 220V.	IP44	1	3
BD9-2234-1020	5/32A. 380V. 2 Pcs. Front-1/16A. 220V. 1 Pc. Panel Socket Front	IP44	1	3
BD9-2234-1182	5/32A. 380V. 2 Pcs. Front-5/16A. 380V. 1 Pc. Front-1/16A. 220V. 2 Pcs. Side	IP44	1	3
BD9-2234-1232	5/32A. 380V. 2 Pcs. Front-3/32A. 220V. 1 Pc. Front-1/16A. 220V. 2 Pcs. Side	IP44	1	3
BD9-2234-2020	Front 2 Pcs. 5/32A. 380V. Side 2 Pcs. 1/16A. 220V.	IP44	1	3
BD9-2234-2024	5/32A. 380V. 2 Pcs. Front-1/16A. 220V. 2 Pcs. Front-1/16A. 220V. 4 Pcs. Side	IP44	1	3
BD9-2234-4020	5/32A. 380V. 2 Pcs. Front-1/16A. 220V. 4 Pcs. Side	IP44	1	3
BD9-2249-2020	5/63A. 380V. 2 Pcs.-1/16A. 220V. 2 Pcs. Side	IP44	1	3
BD9-2301-0000	Empty Box Front 3 Pcs. Hole	IP44	1	3
BD9-2305-2020	3/25A. 380V. 3 Pcs. Front-1/16A. 220V. 2 Pcs. Side	IP44	1	3
BD9-2318-2020	5/16A. 380V. 3 Pcs. Front-1/16A. 220V. 2 Pcs. Side	IP44	1	3
BD9-2334-2020	5/32A. 380V. 3 Pcs. Front-1/16A. 220V. 2 Pcs. Side	IP44	1	3
BD9-2602-6020	1/16A. 220V. 10 Pcs. Front-1/16A. 220V. 2 Pcs. Side	IP44	1	3
BD9-6000-0000	V Automat Rail and 2 Terminal	IP66	1	3
BD9-6000-2020	1/16A. 220V. 2 Pcs. Screwless Socket Side	IP66	1	3
BD9-6130-1020	5/32A. 380V. 1 Pc. Front-1/16A. 220V. 1 Pc. Front	IP66	1	3
BD9-6130-1142	5/32A. 380V. 1 Pc. Front-5/16A. 380V. 1 Pc. Front-1/16A. 220V. 2 Pcs. Side	IP66	1	3
BD9-6130-1241	4/32A. 380V. 1 Pc. Front-5/32A. 380V. 1 Pc. Front-1/16A. 220V. 1 Pc. Front	IP66	1	3
BD9-6224-1302	5/32A. 380V. 1 Pc. Front-4/32A. 380V. 2 Pcs. Front-1/16A. 220V. 2 Pcs. Side	IP66	1	3
BD9-6230-2020	5/32A. 380V. 2 Pcs. Front-1/16A. 220V. 2 Pcs. Side	IP66	1	3
BD9-6314-0000	5/16A. 380V. 3 Pcs. Front	IP66	1	3
BD9-6314-2020	5/16A. 380V. 3 Pcs. Front-1/16A. 220V. 2 Pcs. Side	IP66	1	3
BD9-6324-2020	4/32A. 380V. 3 Pcs. Front-1/16A. 220V. 2 Pcs. Side	IP66	1	3
BD9-6330-2020	5/32A. 380V. 3 Pcs. Front-1/16A. 220V. 2 Pcs. Side	IP66	1	3



**V15 Halogen Free COMBINATIONS  
(300x325x140)**



**15 FUSE CAPACITY**

Product Code	Descriptions	IP	Box	Pack
BH9-2000-0000	V Automat Rail and 2 Terminal	IP44	1	3
BH9-2134-1182	5/32A. 380V. 1 Pc. Front-5/16A. 380V. 1 Pc. Front-1/16A. 220V. 2 Pcs. Side	IP44	1	3
BH9-2134-2120	5/32A. 380V. 1 Pc. Front-4/16A. 380V. 2 Pcs. Front	IP44	1	3
BH9-2144-1282	4/32A. 380V. 1 Pc. Front-4/63A. 380V. 1 Pc. Front-1/16A. 220V. 2 Pcs. Side	IP44	1	3
BH9-2149-2120	5/63A. 380V. 1 Pc. Front-4/16A. 380V. 2 Pcs. Front	IP44	1	3
BH9-2201-2010	Empty Box Front 2 Pcs. Hole - Side 2 Pcs. Hole	IP44	1	3
BH9-2205-1030	3/25A. 380V. 2 Pcs. Front-1/16A. 220V. 1 Pc. Front	IP44	1	3
BH9-2205-4020	3/25A. 380V. 2 Pcs. Front-1/16A. 220V. 4 Pcs. Side	IP44	1	3
BH9-2218-2020	Front 2 Pcs. 5/16A. 380V. Side 2 Pcs. 1/16A. 220V.	IP44	1	3
BH9-2234-1020	5/32A. 380V. 2 Pcs. Front-1/16A. 220V. 1 Pc. Panel Socket Front	IP44	1	3
BH9-2234-1182	5/32A. 380V. 2 Pcs. Front-5/16A. 380V. 1 Pc. Front-1/16A. 220V. 2 Pcs. Side	IP44	1	3
BH9-2234-1232	5/32A. 380V. 2 Pcs. Front-3/32A. 220V. 1 Pc. Front-1/16A. 220V. 2 Pcs. Side	IP44	1	3
BH9-2234-2020	Front 2 Pcs. 5/32A. 380V. Side 2 Pcs. 1/16A. 220V.	IP44	1	3
BH9-2234-2024	5/32A. 380V. 2 Pcs. Front-1/16A. 220V. 2 Pcs. Front-1/16A. 220V. 4 Pcs. Side	IP44	1	3
BH9-2234-4020	5/32A. 380V. 2 Pcs. Front-1/16A. 220V. 4 Pcs. Side	IP44	1	3
BH9-2249-2020	5/63A. 380V. 2 Pcs.-1/16A. 220V. 2 Pcs. Side	IP44	1	3
BH9-2301-0000	Empty Box Front 3 Pcs. Hole	IP44	1	3
BH9-2305-2020	3/25A. 380V. 3 Pcs. Front-1/16A. 220V. 2 Pcs. Side	IP44	1	3
BH9-2318-2020	5/16A. 380V. 3 Pcs. Front-1/16A. 220V. 2 Pcs. Side	IP44	1	3
BH9-2334-2020	5/32A. 380V. 3 Pcs. Front-1/16A. 220V. 2 Pcs. Side	IP44	1	3
BH9-2602-6020	1/16A. 220V. 10 Pcs. Front-1/16A. 220V. 2 Pcs. Side	IP44	1	3
BH9-6000-0000	V Automat Rail and 2 Terminal	IP66	1	3
BH9-6000-2020	1/16A. 220V. 2 Pcs. Screwless Socket Side	IP66	1	3
BH9-6130-1020	5/32A. 380V. 1 Pc. Front-1/16A. 220V. 1 Pc. Front	IP66	1	3
BH9-6130-1142	5/32A. 380V. 1 Pc. Front-5/16A. 380V. 1 Pc. Front-1/16A. 220V. 2 Pcs. Side	IP66	1	3
BH9-6130-1241	4/32A. 380V. 1 Pc. Front-5/32A. 380V. 1 Pc. Front-1/16A. 220V. 1 Pc. Front	IP66	1	3
BH9-6224-1302	5/32A. 380V. 1 Pc. Front-4/32A. 380V. 2 Pcs. Front-1/16A. 220V. 2 Pcs. Side	IP66	1	3
BH9-6230-2020	5/32A. 380V. 2 Pcs. Front-1/16A. 220V. 2 Pcs. Side	IP66	1	3
BH9-6314-0000	5/16A. 380V. 3 Pcs. Front	IP66	1	3
BH9-6314-2020	5/16A. 380V. 3 Pcs. Front-1/16A. 220V. 2 Pcs. Side	IP66	1	3
BH9-6324-2020	4/32A. 380V. 3 Pcs. Front-1/16A. 220V. 2 Pcs. Side	IP66	1	3
BH9-6330-2020	5/32A. 380V. 3 Pcs. Front-1/16A. 220V. 2 Pcs. Side	IP66	1	3



Product Code	Descriptions	IP	Box	Pack
BD4-2000-0000	V Automat Rail and 2 Terminal	IP44	1	5
BD4-2123-1442	3/32A. 220V. 1 Pc. Front-4/63A. 380V. 1 Pc. Front-1/16A. 220V. 2 Pcs. Panel Socket Front	IP44	1	5
BD4-2134-1182	5/32A. 380V. 1 Pc. Front-5/16A. 380V. 1 Pc. Front-1/16A. 220V. 2 Pcs. Side	IP44	1	5
BD4-2134-2120	5/32A. 380V. 1 Pc. Front-4/16A. 380V. 2 Pcs. Front	IP44	1	5
BD4-2134-3020	5/32A. 380V. 1 Pc. Front-1/16A. 220V. 3 Pcs. Panel Socket Front	IP44	1	5
BD4-2144-1282	4/32A. 380V. 1 Pc. Front-4/63A. 380V. 1 Pc. Front-1/16A. 220V. 2 Pcs. Side	IP44	1	5
BD4-2149-2120	5/63A. 380V. 1 Pc. Front-4/16A. 380V. 2 Pcs. Front	IP44	1	5
BD4-2201-2010	Empty Box Front 2 Pcs. Hole - Side 2 Pcs. Hole	IP44	1	5
BD4-2205-1030	3/25A. 380V. 2 Pcs. Front-1/16A. 220V. 1 Pc. Panel Mounted Socket Front	IP44	1	5
BD4-2205-4020	3/25A. 380V. 2 Pcs. Front-1/16A. 220V. 4 Pcs. Side	IP44	1	5
BD4-2218-2020	Front 2 Pcs. 5/16A. 380V. Side 2 Pcs. 1/16A. 220V.	IP44	1	5
BD4-2234-1020	5/32A. 380V. 2 Pcs. Front-1/16A. 220V. 1 Pc. Panel Socket Front	IP44	1	5
BD4-2234-1182	5/32A. 380V. 2 Pcs. Front-5/16A. 380V. 1 Pc. Front-1/16A. 220V. 2 Pcs. Side	IP44	1	5
BD4-2234-1232	5/32A. 380V. 2 Pcs. Front-3/32A. 220V. 1 Pc. Front-1/16A. 220V. 2 Pcs. Side	IP44	1	5
BD4-2234-2020	Front 2 Pcs. 5/32A. 380V. Side 2 Pcs. 1/16A. 220V.	IP44	1	5
BD4-2234-2024	5/32A. 380V. 2 Pcs. Front-1/16A. 220V. 2 Pcs. Front-1/16A. 220V. 4 Pcs. Side	IP44	1	5
BD4-2234-4020	5/32A. 380V. 2 Pcs. Front-1/16A. 220V. 4 Pcs. Side	IP44	1	5
BD4-2249-2020	5/63A. 380V. 2 Pcs.-1/16A. 220V. 2 Pcs. Side	IP44	1	5
BD4-2301-0000	Empty Box Front 3 Pcs. Hole	IP44	1	5
BD4-2305-2020	Front 3 Pcs. 3/25A. 380V. Side 2 Pcs. 1/16A. 220V.	IP44	1	5
BD4-2305-6020	3/25A. 380V. 3 Pcs. Front-1/16A. 220V. 6AD Side	IP44	1	5
BD4-2318-2020	5/16A. 380V. 3 Pcs. Front-1/16A. 220V. 2 Pcs. Side	IP44	1	5
BD4-2318-4020	5/16A. 380V. 3 Pcs. Front-1/16A. 220V. 4 Pcs. Side	IP44	1	5
BD4-2334-2020	Front 3 Pcs. 5/32A. 380V. Side 2 Pcs. 1/16A. 220V.	IP44	1	5
BD4-2334-4020	5/32A. 380V. 3 Pcs. Front-1/16A. 220V. 4 Pcs. Side	IP44	1	5
BD4-2334-6020	5/32A. 380V. 3 Pcs. Front-1/16A. 220V. 6 Pcs. Side	IP44	1	5
BD4-2602-6020	1/16A. 220V. 10 Pcs. Front-1/16A. 220V. 2 Pcs. Side	IP44	1	5
BD4-6000-0000	V Automat Rail and 2 Terminal	IP66	1	5
BD4-6000-2020	1/16A. 220V. 2 Pcs. Screwless Socket Side	IP66	1	5
BD4-6130-1020	5/32A. 380V. 1 Pc. Front-1/16A. 220V. 1 Pc. Front	IP66	1	5
BD4-6130-1142	5/32A. 380V. 1 Pc. Front-5/16A. 380V. 1 Pc. Front-1/16A. 220V. 2 Pcs. Side	IP66	1	5
BD4-6130-1241	4/32A. 380V. 1 Pc. Front-5/32A. 380V. 1 Pc. Front-1/16A. 220V. 1 Pc. Front	IP66	1	5
BD4-6224-1302	5/32A. 380V. 1 Pc. Front-4/32A. 380V. 2 Pcs. Front-1/16A. 220V. 2 Pcs. Side	IP66	1	5
BD4-6230-2020	5/32A. 380V. 2 Pcs. Front-1/16A. 220V. 2 Pcs. Side	IP66	1	5
BD4-6230-4020	Front 2 Pcs. 5/32A. 380V. Side 4 Pcs. 1/16A. 220V. Screwless Panel Socket	IP66	1	5
BD4-6314-0000	5/16A. 380V. 3 Pcs. Front	IP66	1	5
BD4-6314-2020	5/16A. 380V. 3 Pcs. Front-1/16A. 220V. 2 Pcs. Side	IP66	1	5
BD4-6324-2020	4/32A. 380V. 3 Pcs. Front-1/16A. 220V. 2 Pcs. Side	IP66	1	5
BD4-6330-2020	5/32A. 380V. 3 Pcs. Front-1/16A. 220V. 2 Pcs. Side	IP66	1	5



**V17 Halogen Free COMBINATIONS  
(340x340x140)**



**17 FUSE CAPACITY**

Product Code	Descriptions	IP	Box	Pack
BH4-2000-0000	V Automat Rail and 2 Terminal	IP44	1	5
BH4-2123-1442	3/32A. 220V. 1 Pc. Front-4/63A. 380V. 1 Pc. Front-1/16A. 220V. 2 Pcs. Panel Socket Front	IP44	1	5
BH4-2134-1182	5/32A. 380V. 1 Pc. Front-5/16A. 380V. 1 Pc. Front-1/16A. 220V. 2 Pcs. Side	IP44	1	5
BH4-2134-2120	5/32A. 380V. 1 Pc. Front-4/16A. 380V. 2 Pcs. Front	IP44	1	5
BH4-2134-3020	5/32A. 380V. 1 Pc. Front-1/16A. 220V. 3 Pcs. Panel Socket Front	IP44	1	5
BH4-2144-1282	4/32A. 380V. 1 Pc. Front-4/63A. 380V. 1 Pc. Front-1/16A. 220V. 2 Pcs. Side	IP44	1	5
BH4-2149-2120	5/63A. 380V. 1 Pc. Front-4/16A. 380V. 2 Pcs. Front	IP44	1	5
BH4-2201-2010	Empty Box Front 2 Pcs. Hole - Side 2 Pcs. Hole	IP44	1	5
BH4-2205-1030	3/25A. 380V. 2 Pcs. Front-1/16A. 220V. 1 Pc. Panel Mounted Socket Front	IP44	1	5
BH4-2205-4020	3/25A. 380V. 2 Pcs. Front-1/16A. 220V. 4 Pcs. Side	IP44	1	5
BH4-2218-2020	Front 2 Pcs. 5/16A. 380V. Side 2 Pcs. 1/16A. 220V.	IP44	1	5
BH4-2234-1020	5/32A. 380V. 2 Pcs. Front-1/16A. 220V. 1 Pc. Panel Socket Front	IP44	1	5
BH4-2234-1182	5/32A. 380V. 2 Pcs. Front-5/16A. 380V. 1 Pc. Front-1/16A. 220V. 2 Pcs. Side	IP44	1	5
BH4-2234-1232	5/32A. 380V. 2 Pcs. Front-3/32A. 220V. 1 Pc. Front-1/16A. 220V. 2 Pcs. Side	IP44	1	5
BH4-2234-2020	Front 2 Pcs. 5/32A. 380V. Side 2 Pcs. 1/16A. 220V.	IP44	1	5
BH4-2234-2024	5/32A. 380V. 2 Pcs. Front-1/16A. 220V. 2 Pcs. Front-1/16A. 220V. 4 Pcs. Side	IP44	1	5
BH4-2234-4020	5/32A. 380V. 2 Pcs. Front-1/16A. 220V. 4 Pcs. Side	IP44	1	5
BH4-2249-2020	5/63A. 380V. 2 Pcs.-1/16A. 220V. 2 Pcs. Side	IP44	1	5
BH4-2301-0000	Empty Box Front 3 Pcs. Hole	IP44	1	5
BH4-2305-2020	Front 3 Pcs. 3/25A. 380V. Side 2 Pcs. 1/16A. 220V.	IP44	1	5
BH4-2305-6020	3/25A. 380V. 3 Pcs. Front-1/16A. 220V. 6AD Side	IP44	1	5
BH4-2318-2020	5/16A. 380V. 3 Pcs. Front-1/16A. 220V. 2 Pcs. Side	IP44	1	5
BH4-2318-4020	5/16A. 380V. 3 Pcs. Front-1/16A. 220V. 4 Pcs. Side	IP44	1	5
BH4-2334-2020	Front 3 Pcs. 5/32A. 380V. Side 2 Pcs. 1/16A. 220V.	IP44	1	5
BH4-2334-4020	5/32A. 380V. 3 Pcs. Front-1/16A. 220V. 4 Pcs. Side	IP44	1	5
BH4-2334-6020	5/32A. 380V. 3 Pcs. Front-1/16A. 220V. 6 Pcs. Side	IP44	1	5
BH4-2602-6020	1/16A. 220V. 10 Pcs. Front-1/16A. 220V. 2 Pcs. Side	IP44	1	5
BH4-6000-0000	V Automat Rail and 2 Terminal	IP66	1	5
BH4-6000-2020	1/16A. 220V. 2 Pcs. Screwless Socket Side	IP66	1	5
BH4-6130-1020	5/32A. 380V. 1 Pc. Front-1/16A. 220V. 1 Pc. Front	IP66	1	5
BH4-6130-1142	5/32A. 380V. 1 Pc. Front-5/16A. 380V. 1 Pc. Front-1/16A. 220V. 2 Pcs. Side	IP66	1	5
BH4-6130-1241	4/32A. 380V. 1 Pc. Front-5/32A. 380V. 1 Pc. Front-1/16A. 220V. 1 Pc. Front	IP66	1	5
BH4-6224-1302	5/32A. 380V. 1 Pc. Front-4/32A. 380V. 2 Pcs. Front-1/16A. 220V. 2 Pcs. Side	IP66	1	5
BH4-6230-2020	5/32A. 380V. 2 Pcs. Front-1/16A. 220V. 2 Pcs. Side	IP66	1	5
BH4-6230-4020	Front 2 Pcs. 5/32A. 380V. Side 4 Pcs. 1/16A. 220V. Screwless Panel Socket	IP66	1	5
BH4-6314-0000	5/16A. 380V. 3 Pcs. Front	IP66	1	5
BH4-6314-2020	5/16A. 380V. 3 Pcs. Front-1/16A. 220V. 2 Pcs. Side	IP66	1	5
BH4-6324-2020	4/32A. 380V. 3 Pcs. Front-1/16A. 220V. 2 Pcs. Side	IP66	1	5
BH4-6330-2020	5/32A. 380V. 3 Pcs. Front-1/16A. 220V. 2 Pcs. Side	IP66	1	5



**BRAND  
NEW**



**V20 COMBINATIONS  
(220x500x140)**

**20 FUSE CAPACITY**

Product Code	Descriptions	IP	Box	Pack
BD10-2000-0000	V Automat Rail and 2 Terminal	IP44	4	0
BD10-2401-2010	Empty Box Front 4 Pcs. Hole - Side 2 Pcs. Hole	IP44	4	0
BD10-2401-2020	Front 4 Pcs. Hole - Side 2 Pcs. 1/16A. 220V. Panel Socket	IP44	4	0
BD10-2205-4020	Front 2 Pcs. 3/25A. 380V. - Side 4 Pcs. 1/16A. 220V. Panel Socket	IP44	4	0
BD10-2228-2020	Front 2 Pcs. 4/32A. 380V. - Side 2 Pcs. 1/16A. 220V. Panel Socket	IP44	4	0
BD10-2234-2020	Front 2 Pcs. 5/32A. 380V. - Side 2 Pcs. 1/16A. 220V. Panel Socket	IP44	4	0
BD10-2134-1184	Front 1 Pc. 5/32A. - 1 Pc. 5/16A. 380V. - Side 4 Pcs. 1/16A. 220V. Panel Socket	IP44	4	0
BD10-2234-2184	Front 2 Pcs. 5/32A. - 2 Pcs. 5/16A. 380V. - Side 4 Pcs. 1/16A. 220V. Panel Socket	IP44	4	0
BD10-2405-4020	Front 4 Pcs. 3/25A. 380V. - Side 4 Pcs. 1/16A. 220V. Panel Socket	IP44	4	0
BD10-2418-2020	Front 4 Pcs. 5/16A. 380V. - Side 2 Pcs. 1/16A. 220V. Panel Socket	IP44	4	0
BD10-2428-2020	Front 4 Pcs. 4/32A. 380V. - Side 2 Pcs. 1/16A. 220V. Panel Socket	IP44	4	0
BD10-2434-2020	Front 4 Pcs. 5/32A. 380V. - Side 2 Pcs. 1/16A. 220V. Panel Socket	IP44	4	0
BD10-2434-4020	Front 4 Pcs. 5/32A. 380V. - Side 4 Pcs. 1/16A. 220V. Panel Socket	IP44	4	0
BD10-2602-0000	Front 6 Pcs. 1/16A. 220V. Panel Socket	IP44	4	0
BD10-2602-6020	Front 6 Pcs. 1/16A. 220V. - Side 6 Pcs. 1/16A. 220V. Panel Socket	IP44	4	0
BD10-2244-2020	Front 2 Pcs. 4/63A. 380V. - Side 2 Pcs. 1/16A. 220V. Panel Socket	IP44	4	0
BD10-2249-2020	Front 2 Pcs. 5/63A. 380V. - Side 2 Pcs. 1/16A. 220V. Panel Socket	IP44	4	0
BD10-6000-0000	V Automat Rail and 2 Terminal	IP66	4	0
BD10-6414-2020	Front 4 Pcs. 5/16A. 380V. - Side 2 Pcs. 1/16A. 220V. Panel Socket	IP66	4	0
BD10-6430-2020	Front 4 Pcs. 5/32A. 380V. - Side 2 Pcs. 1/16A. 220V. Panel Socket	IP66	4	0
BD10-6424-2020	Front 4 Pcs. 4/32A. 380V. - Side 2 Pcs. 1/16A. 220V. Panel Socket	IP66	4	0
BD10-6430-4020	Front 4 Pcs. 5/32A. 380V. - Side 4 Pcs. 1/16A. 220V. Panel Socket	IP66	4	0
BD10-6240-2020	Front 2 Pcs. 4/63A. 380V. - Side 2 Pcs. 1/16A. 220V. Panel Socket	IP66	4	0
BD10-6245-2020	Front 2 Adet 5/63A. 380V. - Side 2 Pcs. 1/16A. 220V. Panel Socket	IP66	4	0



**V20 Halogen Free COMBINATIONS  
(220x500x140)**



**BRAND  
NEW**

**20 FUSE CAPACITY**

Product Code	Descriptions	IP	Box	Pack
BH10-2000-0000	V Automat Rail and 2 Terminal	IP44	4	0
BH10-2401-2010	Empty Box Front 4 Pcs. Hole - Side 2 Pcs. Hole	IP44	4	0
BH10-2401-2020	Front 4 Pcs. Hole - Side 2 Pcs. 1/16A. 220V. Panel Socket	IP44	4	0
BH10-2205-4020	Front 2 Pcs. 3/25A. 380V. - Side 4 Pcs. 1/16A. 220V. Panel Socket	IP44	4	0
BH10-2228-2020	Front 2 Pcs. 4/32A. 380V. - Side 2 Pcs. 1/16A. 220V. Panel Socket	IP44	4	0
BH10-2234-2020	Front 2 Pcs. 5/32A. 380V. - Side 2 Pcs. 1/16A. 220V. Panel Socket	IP44	4	0
BH10-2134-1184	Front 1 Pc. 5/32A. - 1 Pc. 5/16A. 380V. - Side 4 Pcs. 1/16A. 220V. Panel Socket	IP44	4	0
BH10-2234-2184	Front 2 Pcs. 5/32A. - 2 Pcs. 5/16A. 380V. - Side 4 Pcs. 1/16A. 220V. Panel Socket	IP44	4	0
BH10-2405-4020	Front 4 Pcs. 3/25A. 380V. - Side 4 Pcs. 1/16A. 220V. Panel Socket	IP44	4	0
BH10-2418-2020	Front 4 Pcs. 5/16A. 380V. - Side 2 Pcs. 1/16A. 220V. Panel Socket	IP44	4	0
BH10-2428-2020	Front 4 Pcs. 4/32A. 380V. - Side 2 Pcs. 1/16A. 220V. Panel Socket	IP44	4	0
BH10-2434-2020	Front 4 Pcs. 5/32A. 380V. - Side 2 Pcs. 1/16A. 220V. Panel Socket	IP44	4	0
BH10-2434-4020	Front 4 Pcs. 5/32A. 380V. - Side 4 Pcs. 1/16A. 220V. Panel Socket	IP44	4	0
BH10-2602-0000	Front 6 Pcs. 1/16A. 220V. Panel Socket	IP44	4	0
BH10-2602-6020	Front 6 Pcs. 1/16A. 220V. - Side 6 Pcs. 1/16A. 220V. Panel Socket	IP44	4	0
BH10-2244-2020	Front 2 Pcs. 4/63A. 380V. - Side 2 Pcs. 1/16A. 220V. Panel Socket	IP44	4	0
BH10-2249-2020	Front 2 Pcs. 5/63A. 380V. - Side 2 Pcs. 1/16A. 220V. Panel Socket	IP44	4	0
BH10-6000-0000	V Automat Rail and 2 Terminal	IP66	4	0
BH10-6414-2020	Front 4 Pcs. 5/16A. 380V. - Side 2 Pcs. 1/16A. 220V. Panel Socket	IP66	4	0
BH10-6430-2020	Front 4 Pcs. 5/32A. 380V. - Side 2 Pcs. 1/16A. 220V. Panel Socket	IP66	4	0
BH10-6424-2020	Front 4 Pcs. 4/32A. 380V. - Side 2 Pcs. 1/16A. 220V. Panel Socket	IP66	4	0
BH10-6430-4020	Front 4 Pcs. 5/32A. 380V. - Side 4 Pcs. 1/16A. 220V. Panel Socket	IP66	4	0
BH10-6240-2020	Front 2 Pcs. 4/63A. 380V. - Side 2 Pcs. 1/16A. 220V. Panel Socket	IP66	4	0
BH10-6245-2020	Front 2 Adet 5/63A. 380V. - Side 2 Pcs. 1/16A. 220V. Panel Socket	IP66	4	0

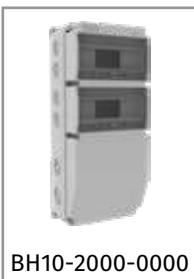

Combinations

Product Code	Descriptions	IP	Box	Pack
BD8-2000-0000	2 Pcs. V Otomat Rail Empty Box	IP44	2	0
BD8-2134-1186	5/32A. 380V. 1 Pc. - 5/16A. 380V. 1 Pc. - 1/16A. 220V. 6 Pcs. Panel Socket Front	IP44	2	0
BD8-2205-4020	3/25A. 380V. 2 Pcs. - 1/16A. 220V. 4 Pcs. Panel Socket Front	IP44	2	0
BD8-2205-4030	3/25A. 380V. 2 Pcs. - 1/16A. 220V. 4 Pcs. Panel Mounted Socket Front	IP44	2	0
BD8-2218-2070	5/16A. 380V. 2 Pcs. - 3/16A. 220V. 2 Pcs. Front	IP44	2	0
BD8-2218-6020	5/16A. 380V. 2 Pcs. - 1/16A. 220V. 6 Pcs. Panel Socket Front	IP44	2	0
BD8-2228-3124	4/16A. 380V. 3 Pcs. - 4/32A. 380V. 2 Pcs. - 1/16A. 220V. 4 Pcs. Panel Socket	IP44	2	0
BD8-2228-6020	4/32A. 380V. 2 Pcs. - 1/16A. 220V. 6 Pcs. Panel Socket Front	IP44	2	0
BD8-2234-2236	5/32A. 380V. 2 Pcs. - 3/32A. 220V. 2 Pcs. - 1/16A. 220V. 6 Pcs. Panel Socket Front	IP44	2	0
BD8-2234-2494	5/32A. 380V. 2 Pcs. - 5/63A. 380V. 2 Pcs. - 1/16A. 220V. 4 Pcs. Panel Socket	IP44	2	0
BD8-2234-3184	5/16A. 380V. 3 Pcs. - 5/32A. 380V. 2 Pcs. - 1/16A. 220V. 4 Pcs. Panel Socket	IP44	2	0
BD8-2234-4020	5/32A. 380V. 2 Pcs. - 1/16A. 220V. 4 Pcs. Panel Socket Front	IP44	2	0
BD8-2234-6020	5/32A. 380V. 2 Pcs. - 1/16A. 220V. 6 Pcs. Panel Socket Front	IP44	2	0
BD8-2249-6020	5/63A. 380V. 2 Pcs. - 1/16A. 220V. 6 Pcs. Front	IP44	2	0
BD8-2305-5025	3/25A. 380V. 3 Pcs. - 1/16A. 220V. 10 Pcs. Panel Socket Front	IP44	2	0
BD8-2328-4020	4/32A. 380V. 3 Pcs. - 1/16A. 220V. 4 Pcs. Panel Socket Front	IP44	2	0
BD8-2334-2020	5/32A. 380V. 3 Pcs. - 1/16A. 220V. 2 Pcs. Panel Socket Front	IP44	2	0
BD8-2334-3070	5/32A. 380V. 3 Pcs. - 3/16A. 220V. 3 Pcs. Front	IP44	2	0
BD8-2334-3184	5/16A. 380V. 3 Pcs. - 5/32A. 380V. 3 Pcs. - 1/16A. 220V. 4 Pcs. Panel Socket Side	IP44	2	0
BD8-2405-4020	Front 4 Pcs. 3/25A. 380V. Front 4 Pcs. 1/16A. 220V. Panel Socket	IP44	2	0
BD8-2405-6020	3/25A. 380V. 4 Pcs. - 1/16A. 220V. 6 Pcs. Panel Socket	IP44	2	0
BD8-2418-6020	5/16A. 380V. 4 Pcs. - 1/16A. 220V. 6 Pcs. Panel Socket	IP44	2	0
BD8-2428-4020	4/32A. 380V. 4 Pcs. - 1/16A. 220V. 4 Pcs. Panel Socket Front	IP44	2	0
BD8-2434-0000	5/32A. 380V. 4 Pcs. Front	IP44	2	0
BD8-2434-2020	Front 4 Pcs. 5/32A. 380V. Front 2 Pcs. 1/16A. 220V. Panel Socket	IP44	2	0
BD8-2434-4020	Front 4 Pcs. 5/32A. 380V. Front 4 Pcs. 1/16A. 220V. Panel Socket	IP44	2	0
BD8-2502-5029	1/16A. 220V. 19 Pcs. Panel Socket Front	IP44	2	0
BD8-2505-6020	3/25A. 380V. 5 Pcs. - 1/16A. 220V. 6 Pcs. Panel Socket	IP44	2	0
BD8-2518-6020	5/16A. 380V. 5 Pcs. - 1/16A. 220V. 6 Pcs. Panel Socket	IP44	2	0
BD8-2605-4020	3/25A. 380V. 6 Pcs. - 1/16A. 220V. 4 Pcs. Panel Socket	IP44	2	0
BD8-2612-0000	4/16A. 380V. 6 Pcs. Front	IP44	2	0
BD8-2618-4020	5/16A. 380V. 6 Pcs. - 1/16A. 220V. 4 Pcs. Panel Socket Side	IP44	2	0
BD8-2634-0000	5/32A. 380V. 6 Pcs. Front	IP44	2	0
BD8-6000-0000	2 Pcs. V Otomat Rail Empty Box	IP66	2	0
BD8-6224-4020	4/32A. 380V. 2 Pcs. - 1/16A. 220V. 4 Pcs. Screwless Socket Front	IP66	2	0
BD8-6230-4032	5/32A. 380V. 2 Pcs. - 3/16A. 220V. 4 Pcs. - 1/16A. 220V. 2 Pcs. Side	IP66	2	0
BD8-6245-2304	5/32A. 380V. 2 Pcs. - 5/63A. 380V. 2 Pcs. - 1/16A. 220V. 4 Pcs.	IP66	2	0
BD8-6255-0000	4/125A. 380V. 2 Pcs. Front	IP66	2	0
BD8-6260-2450	5/125A. 380V. 2 Pcs. - 5/63A. 380V. 2 Pcs.	IP66	2	0
BD8-6330-2450	5/32A. 380V. 3 Pcs. - 5/63A. 380V. 2 Pcs.	IP66	2	0
BD8-6330-3140	5/32A. 380V. 3 Pcs. - 5/16A. 380V. 3 Pcs.	IP66	2	0
BD8-6430-4020	5/32A. 380V. 4 Pcs. - 1/16A. 220V. 2 Pcs. Front - 1/16A. 220V. 2 Pcs. Side	IP66	2	0
BD8-6614-0000	5/16A. 380V. 6 Pcs.	IP66	2	0
BD8-6630-0000	5/32A. 380V. 6 Pcs.	IP66	2	0
BD8-6630-4020	Front 6 Pcs. 5/32A. 380V. Side 4 Pcs. 1/16A. 220V. Screwless Panel Socket	IP66	2	0





**V26 Halogen Free COMBINATIONS  
(300x535x145)**



**26 FUSE CAPACITY**

Product Code	Descriptions	IP	Box	Pack
BH8-2000-0000	2 Pcs. V Otomat Rail Empty Box	IP44	2	0
BH8-2134-1186	5/32A. 380V. 1 Pc. - 5/16A. 380V. 1 Pc. - 1/16A. 220V. 6 Pcs. Panel Socket Front	IP44	2	0
BH8-2205-4020	3/25A. 380V. 2 Pcs. - 1/16A. 220V. 4 Pcs. Panel Socket Front	IP44	2	0
BH8-2205-4030	3/25A. 380V. 2 Pcs. - 1/16A. 220V. 4 Pcs. Panel Mounted Socket Front	IP44	2	0
BH8-2218-2070	5/16A. 380V. 2 Pcs. - 3/16A. 220V. 2 Pcs. Front	IP44	2	0
BH8-2218-6020	5/16A. 380V. 2 Pcs. - 1/16A. 220V. 6 Pcs. Panel Socket Front	IP44	2	0
BH8-2228-3124	4/16A. 380V. 3 Pcs. - 4/32A. 380V. 2 Pcs. - 1/16A. 220V. 4 Pcs. Panel Socket	IP44	2	0
BH8-2228-6020	4/32A. 380V. 2 Pcs. - 1/16A. 220V. 6 Pcs. Panel Socket Front	IP44	2	0
BH8-2234-2236	5/32A. 380V. 2 Pcs. - 3/32A. 220V. 2 Pcs. - 1/16A. 220V. 6 Pcs. Panel Socket Front	IP44	2	0
BH8-2234-2494	5/32A. 380V. 2 Pcs. - 5/63A. 380V. 2 Pcs. - 1/16A. 220V. 4 Pcs. Panel Socket	IP44	2	0
BH8-2234-3184	5/16A. 380V. 3 Pcs. - 5/32A. 380V. 2 Pcs. - 1/16A. 220V. 4 Pcs. Panel Socket	IP44	2	0
BH8-2234-4020	5/32A. 380V. 2 Pcs. - 1/16A. 220V. 4 Pcs. Panel Socket Front	IP44	2	0
BH8-2234-6020	5/32A. 380V. 2 Pcs. - 1/16A. 220V. 6 Pcs. Panel Socket Front	IP44	2	0
BH8-2249-6020	5/63A. 380V. 2 Pcs. - 1/16A. 220V. 6 Pcs. Front	IP44	2	0
BH8-2305-5025	3/25A. 380V. 3 Pcs. - 1/16A. 220V. 10 Pcs. Panel Socket Front	IP44	2	0
BH8-2328-4020	4/32A. 380V. 3 Pcs. - 1/16A. 220V. 4 Pcs. Panel Socket Front	IP44	2	0
BH8-2334-2020	5/32A. 380V. 3 Pcs. - 1/16A. 220V. 2 Pcs. Panel Socket Front	IP44	2	0
BH8-2334-3070	5/32A. 380V. 3 Pcs. - 3/16A. 220V. 3 Pcs. Front	IP44	2	0
BH8-2334-3184	5/16A. 380V. 3 Pcs. - 5/32A. 380V. 3 Pcs. - 1/16A. 220V. 4 Pcs. Panel Socket Side	IP44	2	0
BH8-2405-4020	Front 4 Pcs. 3/25A. 380V. Front 4 Pcs. 1/16A. 220V. Panel Socket	IP44	2	0
BH8-2405-6020	3/25A. 380V. 4 Pcs. - 1/16A. 220V. 6 Pcs. Panel Socket	IP44	2	0
BH8-2418-6020	5/16A. 380V. 4 Pcs. - 1/16A. 220V. 6 Pcs. Panel Socket	IP44	2	0
BH8-2428-4020	4/32A. 380V. 4 Pcs. - 1/16A. 220V. 4 Pcs. Panel Socket Front	IP44	2	0
BH8-2434-0000	5/32A. 380V. 4 Pcs. Front	IP44	2	0
BH8-2434-2020	Front 4 Pcs. 5/32A. 380V. Front 2 Pcs. 1/16A. 220V. Panel Socket	IP44	2	0
BH8-2434-4020	Front 4 Pcs. 5/32A. 380V. Front 4 Pcs. 1/16A. 220V. Panel Socket	IP44	2	0
BH8-2502-5029	1/16A. 220V. 19 Pcs. Panel Socket Front	IP44	2	0
BH8-2505-6020	3/25A. 380V. 5 Pcs. - 1/16A. 220V. 6 Pcs. Panel Socket	IP44	2	0
BH8-2518-6020	5/16A. 380V. 5 Pcs. - 1/16A. 220V. 6 Pcs. Panel Socket	IP44	2	0
BH8-2605-4020	3/25A. 380V. 6 Pcs. - 1/16A. 220V. 4 Pcs. Panel Socket	IP44	2	0
BH8-2612-0000	4/16A. 380V. 6 Pcs. Front	IP44	2	0
BH8-2618-4020	5/16A. 380V. 6 Pcs. - 1/16A. 220V. 4 Pcs. Panel Socket Side	IP44	2	0
BH8-2634-0000	5/32A. 380V. 6 Pcs. Front	IP44	2	0
BH8-6000-0000	2 Pcs. V Otomat Rail Empty Box	IP66	2	0
BH8-6224-4020	4/32A. 380V. 2 Pcs. - 1/16A. 220V. 4 Pcs. Screwless Socket Front	IP66	2	0
BH8-6230-4032	5/32A. 380V. 2 Pcs. - 3/16A. 220V. 4 Pcs. - 1/16A. 220V. 2 Pcs. Side	IP66	2	0
BH8-6245-2304	5/32A. 380V. 2 Pcs. - 5/63A. 380V. 2 Pcs. - 1/16A. 220V. 4 Pcs.	IP66	2	0
BH8-6255-0000	4/125A. 380V. 2 Pcs. Front	IP66	2	0
BH8-6260-2450	5/125A. 380V. 2 Pcs. - 5/63A. 380V. 2 Pcs.	IP66	2	0
BH8-6330-2450	5/32A. 380V. 3 Pcs. - 5/63A. 380V. 2 Pcs.	IP66	2	0
BH8-6330-3140	5/32A. 380V. 3 Pcs. - 5/16A. 380V. 3 Pcs.	IP66	2	0
BH8-6430-4020	5/32A. 380V. 4 Pcs. - 1/16A. 220V. 2 Pcs. Front - 1/16A. 220V. 2 Pcs. Side	IP66	2	0
BH8-6614-0000	5/16A. 380V. 6 Pcs.	IP66	2	0
BH8-6630-0000	5/32A. 380V. 6 Pcs.	IP66	2	0
BH8-6630-4020	Front 6 Pcs. 5/32A. 380V. Side 4 Pcs. 1/16A. 220V. Screwless Panel Socket	IP66	2	0





In pre-assembled combinations, if the fuses are provided by the customer, the fuse installation is done free of charge.

## Cable Mounted Combination Box

V5 - V7 - V10 - V12 - V15 - V17 - V20 - V26



**IP67**

Cable Lug

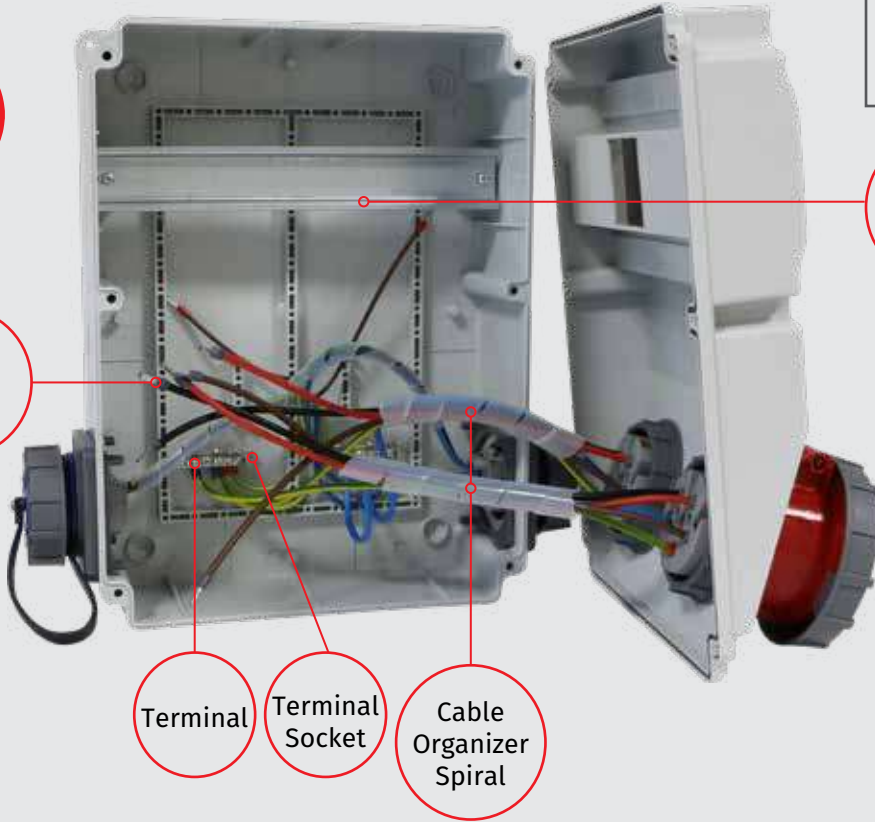

**V10**

Fuse Rail

Terminal

Terminal Socket

Cable Organizer Spiral



**IP44**



**V7**

## V5 Cable Mounted Combination Box

Product Code	Descriptions	IP	Box	Pack
BD1M2105-2020	3/25A. 380V. 1 Pc. Front - 1/16A. 220V. 2 Pcs. Side (ABS)	IP44	1	12
BD1M2118-2020	5/16A. 380V. 1 Pc. Front - 1/16A. 220V. 2 Pcs. Side (ABS)	IP44	1	12
BD1M2134-2020	5/32A. 380V. 1 Pc. Front - 1/16A. 220V. 2 Pcs. Side (ABS)	IP44	1	12
BH1M2105-2020	3/25A. 380V. 1 Pc. Front - 1/16A. 220V. 2 Pcs. Side (ABS-H.F.)	IP44	1	12
BH1M2118-2020	5/16A. 380V. 1 Pc. Front - 1/16A. 220V. 2 Pcs. Side (ABS-H.F.)	IP44	1	12
BH1M2134-2020	5/32A. 380V. 1 Pc. Front - 1/16A. 220V. 2 Pcs. Side (ABS-H.F.)	IP44	1	12
BD1M6114-2020	5/16A. 380V. IP67 1 Pc. Front - 1/16A. 220V. IP68 2 Pcs. Side (ABS)	IP66	1	12
BD1M6130-2020	5/32A. 380V. IP67 1 Pc. Front - 1/16A. 220V. IP68 2 Pcs. Side (ABS)	IP66	1	12
BH1M6114-2020	5/16A. 380V. IP67 1 Pc. Front - 1/16A. 220V. IP68 2 Pcs. Side (ABS-H.F.)	IP66	1	12
BH1M6130-2020	5/32A. 380V. IP67 1 Pc. Front - 1/16A. 220V. IP68 2 Pcs. Side (ABS-H.F.)	IP66	1	12

## V7 Cable Mounted Combination Box

Product Code	Descriptions	IP	Box	Pack
BD5M2105-2020	3/25A. 380V. 1 Pc. Front - 1/16A. 220V. 2 Pcs. Side (ABS)	IP44	1	12
BD5M2118-2020	5/16A. 380V. 1 Pc. Front - 1/16A. 220V. 2 Pcs. Side (ABS)	IP44	1	12
BD5M2134-2020	5/32A. 380V. 1 Pc. Front - 1/16A. 220V. 2 Pcs. Side (ABS)	IP44	1	12
BH5M2105-2020	3/25A. 380V. 1 Pc. Front - 1/16A. 220V. 2 Pcs. Side (ABS-H.F.)	IP44	1	12
BH5M2118-2020	5/16A. 380V. 1 Pc. Front - 1/16A. 220V. 2 Pcs. Side (ABS-H.F.)	IP44	1	12
BH5M2134-2020	5/32A. 380V. 1 Pc. Front - 1/16A. 220V. 2 Pcs. Side (ABS-H.F.)	IP44	1	12
BD5M6114-2020	5/16A. 380V. 1 Pc. Front - 1/16A. 220V. 2 Pcs. Side (ABS)	IP66	1	12
BD5M6130-2020	5/32A. 380V. 1 Pc. Front - 1/16A. 220V. 2 Pcs. Side (ABS)	IP66	1	12
BH5M6114-2020	5/16A. 380V. 1 Pc. Front - 1/16A. 220V. 2 Pcs. Side (ABS-H.F.)	IP66	1	12
BH5M6130-2020	5/32A. 380V. 1 Pc. Front - 1/16A. 220V. 2 Pcs. Side (ABS-H.F.)	IP66	1	12

## V10 Cable Mounted Combination Box

Product Code	Descriptions	IP	Box	Pack
BD2M2205-2020	3/25A. 380V. 2 Pcs. Front - 1/16A. 220V. 2 Pcs. Side (ABS)	IP44	1	6
BD2M2218-2020	5/16A. 380V. 2 Pcs. Front - 1/16A. 220V. 2 Pcs. Side (ABS)	IP44	1	6
BD2M2234-2020	5/32A. 380V. 2 Pcs. Front - 1/16A. 220V. 2 Pcs. Side (ABS)	IP44	1	6
BH2M2205-2020	3/25A. 380V. 2 Pcs. Front - 1/16A. 220V. 2 Pcs. Side (ABS-H.F.)	IP44	1	6
BH2M2218-2020	5/16A. 380V. 2 Pcs. Front - 1/16A. 220V. 2 Pcs. Side (ABS-H.F.)	IP44	1	6
BH2M2234-2020	5/32A. 380V. 2 Pcs. Front - 1/16A. 220V. 2 Pcs. Side (ABS-H.F.)	IP44	1	6
BD2M6214-2020	5/16A. 380V. IP67 2 Pcs. Front - 1/16A. 220V. IP68 2 Pcs. Side (ABS)	IP66	1	6
BD2M6230-2020	5/32A. 380V. IP67 2 Pcs. Front - 1/16A. 220V. IP68 2 Pcs. Side (ABS)	IP66	1	6
BH2M6214-2020	5/16A. 380V. IP67 2 Pcs. Front - 1/16A. 220V. IP68 2 Pcs. Side (ABS-H.F.)	IP66	1	6
BH2M6230-2020	5/32A. 380V. IP67 2 Pcs. Front - 1/16A. 220V. IP68 2 Pcs. Side (ABS-H.F.)	IP66	1	6

## V12 Cable Mounted Combination Box

Product Code	Descriptions	IP	Box	Pack
BD6M2205-2020	3/25A. 380V. 2 Pcs. Front - 1/16A. 220V. 2 Pcs. Side (ABS)	IP44	1	6
BD6M2218-2020	5/16A. 380V. 2 Pcs. Front - 1/16A. 220V. 2 Pcs. Side (ABS)	IP44	1	6
BD6M2234-2020	5/32A. 380V. 2 Pcs. Front - 1/16A. 220V. 2 Pcs. Side (ABS)	IP44	1	6
BH6M2205-2020	3/25A. 380V. 2 Pcs. Front - 1/16A. 220V. 2 Pcs. Side (ABS-H.F.)	IP44	1	6
BH6M2218-2020	5/16A. 380V. 2 Pcs. Front - 1/16A. 220V. 2 Pcs. Side (ABS-H.F.)	IP44	1	6
BH6M2234-2020	5/32A. 380V. 2 Pcs. Front - 1/16A. 220V. 2 Pcs. Side (ABS-H.F.)	IP44	1	6
BD6M6214-2020	5/16A. 380V. 2 Pcs. Front - 1/16A. 220V. 2 Pcs. Panel Mounted Socket Side (ABS)	IP66	1	6
BD6M6230-2020	5/32A. 380V. 2 Pcs. Front - 1/16A. 220V. 2 Pcs. Panel Mounted Socket Side (ABS)	IP66	1	6
BH6M6214-2020	5/16A. 380V. 2 Pcs. Front - 1/16A. 220V. 2 Pcs. Panel Mounted Socket Side (ABS-H.F.)	IP66	1	6
BH6M6230-2020	5/32A. 380V. 2 Pcs. Front - 1/16A. 220V. 2 Pcs. Panel Mounted Socket Side (ABS-H.F.)	IP66	1	6

# Cable Mounted Combination Box



## V15 Cable Mounted Combination Box

Product Code	Descriptions	IP	Box	Pack
BD9M2305-2020	3/25A. 380V. 3 Pcs. Front - 1/16A. 220V. 2 Pcs. Side (ABS)	IP44	1	2
BD9M2318-2020	5/16A. 380V. 3 Pcs. Front - 1/16A. 220V. 2 Pcs. Side (ABS)	IP44	1	2
BD9M2334-2020	5/32A. 380V. 3 Pcs. Front - 1/16A. 220V. 2 Pcs. Side (ABS)	IP44	1	2
BH9M2305-2020	3/25A. 380V. 3 Pcs. Front - 1/16A. 220V. 2 Pcs. Side (ABS-H.F.)	IP44	1	2
BH9M2318-2020	5/16A. 380V. 3 Pcs. Front - 1/16A. 220V. 2 Pcs. Side (ABS-H.F.)	IP44	1	2
BH9M2334-2020	5/32A. 380V. 3 Pcs. Front - 1/16A. 220V. 2 Pcs. Side (ABS-H.F.)	IP44	1	2
BD9M6314-2020	5/16A. 380V. 3 Pcs. Front - 1/16A. 220V. 2 Pcs. Panel Mounted Socket Side (ABS)	IP66	1	2
BD9M6330-2020	5/32A. 380V. 3 Pcs. Front - 1/16A. 220V. 2 Pcs. Panel Mounted Socket Side (ABS)	IP66	1	2
BH9M6314-2020	5/16A. 380V. 3 Pcs. Front - 1/16A. 220V. 2 Pcs. Panel Mounted Socket Side (ABS-H.F.)	IP66	1	2
BH9M6330-2020	5/32A. 380V. 3 Pcs. Front - 1/16A. 220V. 2 Pcs. Panel Mounted Socket Side (ABS-H.F.)	IP66	1	2

## V17 Cable Mounted Combination Box

Product Code	Descriptions	IP	Box	Pack
BD4M2305-2020	3/25A. 380V. 3 Pcs. Front - 1/16A. 220V. 2 Pcs. Side (ABS)	IP44	1	2
BD4M2318-2020	5/16A. 380V. 3 Pcs. Front - 1/16A. 220V. 2 Pcs. Side (ABS)	IP44	1	2
BD4M2334-2020	5/32A. 380V. 3 Pcs. Front - 1/16A. 220V. 2 Pcs. Side (ABS)	IP44	1	2
BH4M2305-2020	3/25A. 380V. 3 Pcs. Front - 1/16A. 220V. 2 Pcs. Side (ABS-H.F.)	IP44	1	2
BH4M2318-2020	5/16A. 380V. 3 Pcs. Front - 1/16A. 220V. 2 Pcs. Side (ABS-H.F.)	IP44	1	2
BH4M2334-2020	5/32A. 380V. 3 Pcs. Front - 1/16A. 220V. 2 Pcs. Side (ABS-H.F.)	IP44	1	2
BD4M6314-2020	5/16A. 380V. 3 Pcs. Front - 1/16A. 220V. 2 Pcs. Panel Mounted Socket Side (ABS)	IP66	1	2
BD4M6330-2020	5/32A. 380V. 3 Pcs. Front - 1/16A. 220V. 2 Pcs. Panel Mounted Socket Side (ABS)	IP66	1	2
BH4M6314-2020	5/16A. 380V. 3 Pcs. Front - 1/16A. 220V. 2 Pcs. Panel Mounted Socket Side (ABS-H.F.)	IP66	1	2
BH4M6330-2020	5/32A. 380V. 3 Pcs. Front - 1/16A. 220V. 2 Pcs. Panel Mounted Socket Side (ABS-H.F.)	IP66	1	2

## V20 Cable Mounted Combination Box

Product Code	Descriptions	IP	Box	Pack
BD10M2234-2184	5/32A. 380V. 2 Pcs. - 5/16A. 380V. 2 Pcs. Front - 1/16A. 220V. 4 Pcs. Side (ABS)	IP44	1	4
BD10M2418-2020	5/16A. 380V. 4 Pcs. Front - 1/16A. 220V. 2 Pcs. Side (ABS)	IP44	1	4
BD10M2434-4020	5/32A. 380V. 4 Pcs. Front - 1/16A. 220V. 4 Pcs. Side (ABS)	IP44	1	4
BD10M2249-2020	5/63A. 380V. 2 Pcs. Front - 1/16A. 220V. 2 Pcs. Side (ABS)	IP44	1	4
BD10M6430-2020	5/32A. 380V. 4 Pcs. Front - 1/16A. 220V. 2 Pcs. Side (ABS)	IP67	1	4
BD10M6240-2020	4/63A. 380V. 2 Pcs. Front - 1/16A. 220V. 2 Pcs. Side (ABS)	IP67	1	4
BH10M2234-2184	5/32A. 380V. 2 Pcs. - 5/16A. 380V. 2 Pcs. Front - 1/16A. 220V. 4 Pcs. Side (ABS-H.F.)	IP44	1	4
BH10M2418-2020	5/16A. 380V. 4 Pcs. Front - 1/16A. 220V. 2 Pcs. Side (ABS-H.F.)	IP44	1	4
BH10M2434-4020	5/32A. 380V. 4 Pcs. Front - 1/16A. 220V. 4 Pcs. Side (ABS-H.F.)	IP44	1	4
BH10M2249-2020	5/63A. 380V. 2 Pcs. Front - 1/16A. 220V. 2 Pcs. Side (ABS-H.F.)	IP44	1	4
BH10M6430-2020	5/32A. 380V. 4 Pcs. Front - 1/16A. 220V. 2 Pcs. Side (ABS-H.F.)	IP66	1	4
BH10M6240-2020	4/63A. 380V. 2 Pcs. Front - 1/16A. 220V. 2 Pcs. Side (ABS-H.F.)	IP66	1	4

## V26 Cable Mounted Combination Box

Product Code	Descriptions	IP	Box	Pack
BD8M2405-4020	4 Pcs. 3/25A. 380V. Front - 4 Pcs. 1/16A. 220V. Front Panel Socket (ABS)	IP44	1	0
BD8M2418-4020	5/16A. 380V. 4 Pcs. Front - 1/16A. 220V. 4 Pcs. Side (ABS)	IP44	1	0
BD8M2434-4020	4 Pcs. 5/32A. 380V. Front - 4 Pcs. 1/16A. 220V. Front Panel Socket (ABS)	IP44	1	0
BH8M2405-4020	4 Pcs. 3/25A. 380V. Front - 4 Pcs. 1/16A. 220V. Front Panel Socket (ABS-H.F.)	IP44	1	0
BH8M2418-4020	5/16A. 380V. 4 Pcs. Front - 1/16A. 220V. 4 Pcs. Side (ABS-H.F.)	IP44	1	0
BH8M2434-4020	4 Pcs. 5/32A. 380V. Front - 4 Pcs. 1/16A. 220V. Front Panel Socket (ABS-H.F.)	IP44	1	0
BD8M6230-8030	2 Pcs. 5/32A. 380V. Front - 8 Pcs. 1/16A. 220V. Front Panel Socket (ABS)	IP66	1	0
BD8M6414-4020	5/16A. 380V. 4 Pcs. Front - 1/16A. 220V. 4 Pcs. Side (ABS)	IP66	1	0
BH8M6230-8030	2 Pcs. 5/32A. 380V. Front - 8 Pcs. 1/16A. 220V. Front Panel Socket (ABS-H.F.)	IP66	1	0
BH8M6414-4020	5/16A. 380V. 4 Pcs. Front - 1/16A. 220V. 4 Pcs. Side (ABS-H.F.)	IP66	1	0

Product Code	Descriptions	IP	Box	Pack
BD8A2000-0000	Empty Combination	IP44	1	0
BD8A2234-4020	5/32A. 380V. 2 Pcs. - 1/16A. 220V. 4 Pcs.	IP44	1	0
BD8A2434-4020	5/32A. 380V. 4 Pcs. - 1/16A. 220V. 4 Pcs.	IP44	1	0
BD8A2418-4020	5/16A. 380V. 4 Pcs. - 1/16A. 220V. 4 Pcs.	IP44	1	0
BD8A6224-4020	4/32A. 380V. 2 Pcs. - 1/16A. 220V. 4 Pcs.	IP66	1	0
BD8A6230-4020	5/32A. 380V. 2 Pcs. - 1/16A. 220V. 4 Pcs.	IP66	1	0



**Mini Combinations (120x170x110)**  
**IP44 / IP67 Our Models**



Product Code	Descriptions	IP	Box	Pack
BD7-2000-0000	Empty Combination 120X170X110	IP44	1	16
BD7-2107-0000	Front 1 Pc. 3/16A. 220V. Panel Mounted Socket	IP44	1	16
BD7-2107-1090	Front 1 Pc. Pako Switch - 1 Pc. 3/16A. 220V. Panel Mounted Socket	IP44	1	16
BD7-2107-2020	Front 2 Pcs. 1/16A. 220V. Panel Socket - 1 Pc. 3/16A. 220V. Panel Mounted Socket	IP44	1	16
BD7-2118-0000	Front 1 Pc. 5/16A. 380V. Panel Mounted Socket	IP44	1	16
BD7-2118-1090	Front 1 Pc. Pako Switch - 1 Pc. 5/16A. 380V. Panel Mounted Socket	IP44	1	16
BD7-2118-2020	Front 2 Pcs. 1/16A. 220V. Panel Socket - 1 Pc. 5/16A. 380V. Panel Mounted Socket	IP44	1	16
BD7-2134-0000	Front 1 Pc. 5/32A. 380V. Panel Mounted Socket	IP44	1	16
BD7-2134-1090	Front 1 Pc. Pako Switch - 1 Pc. 5/32A. 380V. Panel Mounted Socket	IP44	1	16
BD7-2134-2020	Front 2 Pcs. 1/16A. 220V. Panel Socket - 1 Pc. 5/32A. 380V. Panel Mounted Socket	IP44	1	16
BD7-2402-0000	Front 4 Pcs. 1/16A. 220V. Panel Socket	IP44	1	16
BD7-2402-2020	Front 4 Pcs. 1/16A. 220V. Side 2 Pcs. 1/16A. 220V. Panel Socket	IP44	1	16
BD7-6000-0000	Empty Combination 120X170X110	IP66	1	16
BD7-6103-0000	Front 1 Pc. 3/16A. 220V. Panel Mounted Socket	IP66	1	16
BD7-6103-1090	Front 1 Pc. Pako Switch - 1 Pc. 3/16A. 220V. Panel Mounted Socket	IP65	1	16
BD7-6114-0000	Front 1 Pc. 5/16A. 380V. Panel Mounted Socket	IP66	1	16
BD7-6114-1090	Front 1 Pc. Pako Switch - 1 Pc. 5/16A. 380V. Panel Mounted Socket	IP65	1	16
BD7-6114-1092	Front 1 Pc. Pako Switch 1 Pc. 5/16A. 380V. Side 2 Pcs. 1/16A. 220V. Panel Mounted Socket	IP66	1	16
BD7-6114-2020	Front 1 Pc. 5/16A. 380V. Side 2 Pcs. 1/16A. 220V. Panel Mounted Socket	IP65	1	16
BD7-6130-0000	Front 1 Pc. 5/32A. 380V. Panel Mounted Socket	IP66	1	16
BD7-6130-1090	Front 1 Pc. Pako Switch - 1 Pc. 5/32A. 380V. Panel Mounted Socket	IP66	1	16
BD7-6130-1092	Front 1 Pc. Pako Switch 1 Pc. 5/32A. 380V. Side 2 Pcs. 1/16A. 220V. Panel Mounted Socket	IP65	1	16
BD7-6130-2020	Front 1 Pc. 5/32A. 380V. Side 2 Pcs. 1/16A. 220V. Panel Mounted Socket	IP65	1	16



BD7-2000-0000

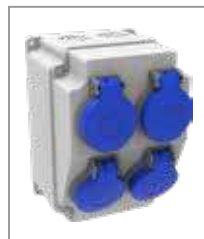

BD7-2402-0000



BD7-2402-2020



BD7-2107-4020



BD7-6103-4020

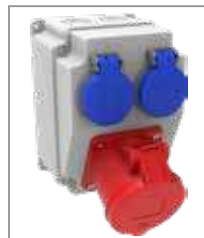

BD7-2134-2020

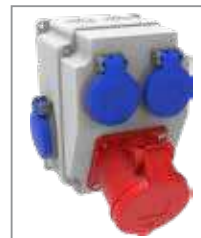

BD7-2134-4020



BD7-2107-1090



BD7-6130-2020



BD7-6103-1090



BD7-6130-1090



BD7-6130-1092



 **bemis**



# Aluminum Combinations

## 190x350x90

Product Code	Descriptions	Fuse Cap.	IP	Pack
BB4-7162-8210	5/32A. 380V. 2 Pcs. Front - 1/16A. 220V. 2 Pcs. Side	8 Fuse Cap.	IP67	3
BB4-7162-H2F0	5/16A. 380V. 45° Angled 2 Pcs. 3/16A. 220V. 45° Angled 2 Pcs.	8 Fuse Cap.	IP67	3

## 230x330x140

Product Code	Descriptions	Fuse Cap.	IP	Pack
BB4-2192-8210	5/32A. 380V. 2 Pcs. 1/16A. 220V. 2 Pcs.	8 Fuse Cap.	IP44	1
BB4-7190-0000	Empty Aluminum Combination	8 Fuse Cap.	IP67	1
BB4-7191-8210	5/32A. 380V. 1 Pc. Front - 1/16A. 220V. Side 2 Pcs.	8 Fuse Cap.	IP67	1
BB4-7192-8210	5/32A. 380V. 2 Pcs. 1/16A. 220V. 2 Pcs.	8 Fuse Cap.	IP67	1
BB4-7192-8310	5/32A. 380V. 2 Pcs. 3/16A. 2 Pcs. 1/16A. 220V. 2 Pcs. (Without Fuse Module)	-	IP67	1
BB4-7192-H210	5/16A. 380V. 45° Angled 2 Pcs. Front 1/16A. 220V. 2 Pcs. Side	8 Fuse Cap.	IP67	1
BB4-7192-J210	5/32A. 380V. 45° Angled 2 Pcs. 1/16A. 220V. 2 Pcs. Side	8 Fuse Cap.	IP67	1
BB4M7192-8210	5/32A. 380V. 2 Pcs. 1/16A. 220V. 2 Pcs.	8 Fuse Cap.	IP67	1
BB4M7192-J210	5/32A. 380V. 45° Angled 2 Pcs. 1/16A. 220V. 2 Pcs.	8 Fuse Cap.	IP67	1

## 310x400x140

Product Code	Descriptions	Fuse Cap.	IP	Pack
BB4-2184-8410	5/32A. 380V. 4 Pcs. 1/16A. 220V. 4 Pcs. (Without Fuse Module)	-	IP44	2
BB4-2182-8410	5/32A. 380V. 2 Pcs. 1/16A. 220V. 4 Pcs.	12 Fuse Cap.	IP44	2
BB4-2182-8222	5/32A. 2 Pcs. 3/25A. 2 Pcs. Front - 1/16A. 220V. 2 Pcs. Side	12 Fuse Cap.	IP44	2
BB4-7180-0000	Empty Aluminum Combination	12 Fuse Cap.	IP67	2
BB4-7181-8210	5/32A. 380V. 1 Pc. 1/16A. 220V. 2 Pcs.	12 Fuse Cap.	IP67	2
BB4-7182-7210	4/32A. 380V. 2 Pcs. 1/16A. 220V. 2 Pcs.	12 Fuse Cap.	IP67	2
BB4-7183-8000	5/32A. 380V. 3 Pcs.	12 Fuse Cap.	IP67	2
BB4-7182-8000	5/32A. 380V. 2 Pcs.	12 Fuse Cap.	IP67	2
BB4-7184-8210	5/32A. 380V. 4 Pcs. Front - 1/16A. 220V. 2 Pcs. Side	12 Fuse Cap.	IP67	2
BB4-7182-8210	5/32A. 380V. 2 Pcs. 1/16A. 220V. 2 Pcs.	12 Fuse Cap.	IP67	2
BB4-7182-J210	5/32A. 380V. 45° Angled 2 Pcs. 1/16A. 220V. 2 Pcs.	12 Fuse Cap.	IP67	2
BB4-7182-8410	5/32A. 380V. 2 Pcs. 1/16A. 220V. 4 Pcs.	12 Fuse Cap.	IP67	2
BB4-7181-B210	5/63A. 380V. 1 Pc. 1/16A. 220V. 2 Pcs.	12 Fuse Cap.	IP67	2
BB4M7182-8210	5/32A. 380V. 2 Pcs. 1/16A. 220V. 2 Pcs.	12 Fuse Cap.	IP67	2
BB4M7182-J210	5/32A. 380V. 45° Angled 2 Pcs. 1/16A. 220V. 2 Pcs.	12 Fuse Cap.	IP67	2
BB4M7181-B210	5/63A. 380V. 1 Pc. 1/16A. 220V. 2 Pcs.	12 Fuse Cap.	IP67	2



BB4-2182-8410



BB4-2184-8410



BB4-2192-8210



BB4-7182-8410



BB4-7162-H2F0



BB4-7183-8000



BB4-7191-8321



BB4-7192-J210



BB4-7192-8210

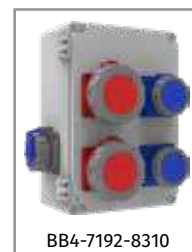

BB4-7192-8310

Product Code	Dimensions	IP	Box	Pack
BPA-1001-0016	200x300x130 mm	IP65	1	0
BPA-1101-0116	500X600X220 mm	IP65	1	0
BPA-2001-0026	250x350x150 mm	IP65	1	0
BPA-3001-0036	300x400x170 mm	IP65	1	0
BPA-3001-0106	300x400x220 mm	IP65	1	0
BPA-4001-0046	350x500x190 mm	IP65	1	0
BPA-5001-0056	400x500x180 mm	IP65	1	0
BPA-6001-0066	400x500x240 mm	IP65	1	0
BPA-7001-0076	400x600x200 mm	IP65	1	0
BPA-8001-0086	500x700x250 mm	IP65	1	0
BPA-9001-0096	600x800x260 mm	IP65	1	0

*Opaque Cover ABS Board*

Product Code	Dimensions	IP	Box	Pack
BPC-1001-0016	200x300x130 mm	IP65	1	0
BPC-1101-0116	500X600X220 mm	IP65	1	0
BPC-2001-0026	250x350x150 mm	IP65	1	0
BPC-3001-0036	300x400x170 mm	IP65	1	0
BPC-3001-0106	300x400x220 mm	IP65	1	0
BPC-4001-0046	350x500x190 mm	IP65	1	0
BPC-5001-0056	400x500x180 mm	IP65	1	0
BPC-6001-0066	400x500x240 mm	IP65	1	0
BPC-7001-0076	400x600x200 mm	IP65	1	0
BPC-8001-0086	500x700x250 mm	IP65	1	0
BPC-9001-0096	600x800x260 mm	IP65	1	0

*Transparent Cover ABS Board*



Transparent Cover ABS Board

- 650°C durable fireproof body
- Halogen free

**IK 10**  
**IP 65**

**5 YEAR WARRANTY**

**CE**



Opaque Cover ABS Board



Product Code	Descriptions	Product Dimensions (mm)	IP	Box	Pack
BB1-0141-0003	Press Lid	Diameter Ø70	IP44	27	216
BB1-0241-0003	Press Lid	Diameter Ø90	IP44	20	160
BB1-0341-0003	Press Lid	85x85x50	IP44	75	0
BB1-0431-0083	Screw Lid	95x95x60	IP44	8	64
BB1-0441-0003	Press Lid	95x95x50	IP44	8	96
BB1-0521-0063	Transparent Cover	120x120x140	IP44	1	60
BB1-0531-0003	Screw Lid	120x120x70	IP44	6	48
BB1-0531-0063	Screw Lid	120x120x140	IP44	1	60
BB1-0621-0063	Transparent Cover	120x224x140	IP44	1	30
BB1-0631-0003	Screw Lid	120x255x80	IP44	10	0
BB1-0631-0063	Screw Lid	120x224x140	IP44	1	30
BB1-0721-0063	Transparent Cover	220x300x140	IP44	1	10
BB1-0731-0003	Screw Lid	210x300x90	IP44	4	0
BB1-0731-0063	Screw Lid	220x300x140	IP44	1	10
BB1-0921-0023	Transparent Cover	120x170x70	IP44	15	0
BB1-0921-0063	Transparent Cover	120x170x140	IP44	1	40
BB1-0931-0023	Screw Lid	120x170x70	IP44	15	20
BB1-0931-0063	Screw Lid	120x170x140	IP44	1	40
BB1-1021-0073	Transparent Cover	340x340x160	IP44	1	6
BB1-1031-0073	Screw Lid	340x340x160	IP44	1	6
BB1-1121-0053	Transparent Cover	110x110x100	IP44	4	48
BB1-1131-0053	Screw Lid	110x110x100	IP44	4	48
BB1-1221-0092	Transparent Cover	300x535x150	IP44	2	0
BB1-1231-0023	Screw Lid	110x110x70	IP44	6	48
BB1-1231-0092	Screw Lid	300x535x150	IP44	2	0
BB1-1331-0023	Screw Lid	110x150x70	IP44	4	32
BB1-1631-0023	Screw Lid	110x180x70	IP44	4	32
BB1-1531-0063	Screw Lid	200x500x140	IP44	1	4
BB1-1521-0063	Transparent Cover	200x500x140	IP44	1	4

Brand New  
Brand New  
Brand New

70 mm  BB2-0141-0003 Halogen Free IP44 BB1-0141-0003	90 mm  BB2-0241-0003 Halogen Free IP44 BB1-0241-0003	85x85x50  BB2-0341-0003 Halogen Free IP44 BB1-0341-0003	95x95x50  BB2-0441-0003 Halogen Free IP44 BB1-0441-0003	95x95x60  BB2-0431-0083 / IP44 BB2-0431-0086 / IP67 Halogen Free BB1-0431-0083 / IP44 BB1-0431-0086 / IP67	110x110x70  BB2-1231-0023 / IP44 BB2-1231-0026 / IP67 Halogen Free BB1-1231-0023 / IP44 BB1-1231-0026 / IP67
110x110x100  BB2-1131-0053 / IP44 BB2-1131-0056 / IP67 Halogen Free BB1-1131-0053 / IP44 BB1-1131-0056 / IP67	110x110x100  BB2-1121-0053 / IP44 BB2-1121-0056 / IP67 Halogen Free BB1-1121-0053 / IP44 BB1-1121-0056 / IP67	120x120x70  BB2-0531-0003 / IP44 BB2-0531-0006 / IP67 Halogen Free BB1-0531-0003 / IP44 BB1-0531-0006 / IP67	120x120x140  BB2-0531-0063 / IP44 BB2-0531-0066 / IP67 Halogen Free BB1-0531-0063 / IP44 BB1-0531-0066 / IP67	120x120x140  BB2-0521-0063 / IP44 BB2-0521-0066 / IP67 Halogen Free BB1-0521-0063 / IP44 BB1-0521-0066 / IP67	110x150x70  BB2-1331-0023 / IP44 BB2-1331-0026 / IP67 Halogen Free BB1-1331-0023 / IP44 BB1-1331-0026 / IP67

# Plastic Enclosure Box

## ABS / IP44



Product Code	Descriptions	Product Dimensions (mm)	IP	Box	Pack
BB2-0141-0003	Press Lid	Diameter Ø70	IP44	27	216
BB2-0241-0003	Press Lid	Diameter Ø90	IP44	20	160
BB2-0341-0003	Press Lid	85x85x50	IP44	75	0
BB2-0431-0083	Screw Lid	95x95x60	IP44	8	64
BB2-0441-0003	Press Lid	95x95x50	IP44	8	96
BB2-0521-0063	Transparent Cover	120x120x140	IP44	1	60
BB2-0531-0003	Screw Lid	120x120x70	IP44	6	48
BB2-0531-0063	Screw Lid	120x120x140	IP44	1	60
BB2-0621-0063	Transparent Cover	120x224x140	IP44	1	30
BB2-0631-0003	Screw Lid	120x255x80	IP44	10	0
BB2-0631-0063	Screw Lid	120x224x140	IP44	1	30
BB2-0721-0063	Transparent Cover	220x300x140	IP44	1	10
BB2-0731-0003	Screw Lid	210x300x90	IP44	4	0
BB2-0731-0063	Screw Lid	220x300x140	IP44	1	10
BB2-0921-0023	Transparent Cover	120x170x70	IP44	15	0
BB2-0921-0063	Transparent Cover	120x170x140	IP44	1	40
BB2-0931-0023	Screw Lid	120x170x70	IP44	15	0
BB2-0931-0063	Screw Lid	120x170x140	IP44	1	40
BB2-1021-0073	Transparent Cover	340x340x160	IP44	1	6
BB2-1031-0073	Screw Lid	340x340x160	IP44	1	6
BB2-1121-0053	Transparent Cover	110x110x100	IP44	4	48
BB2-1131-0053	Screw Lid	110x110x100	IP44	4	48
BB2-1221-0092	Transparent Cover	300x535x150	IP44	2	0
BB2-1231-0023	Screw Lid	110x110x70	IP44	6	48
BB2-1231-0092	Screw Lid	300x535x150	IP44	2	0
BB2-1331-0023	Screw Lid	110x150x70	IP44	4	32
BB2-1631-0023	Screw Lid	110x180x70	IP44	4	32
BB2-1531-0063	Screw Lid	200x500x140	IP44	1	4
BB2-1521-0063	Transparent Cover	200x500x140	IP44	1	4

Brand New  
Brand New  
Brand New

<p>110x180x70</p>  <p>BB2-1631-0023 / IP44 BB2-1631-0026 / IP67</p> <p>Halogen Free BB1-1631-0023 / IP44 BB1-1631-0026 / IP67</p>	<p>120x170x70</p>  <p>BB2-0931-0023 / IP44 BB2-0931-0026 / IP67</p> <p>Halogen Free BB1-0931-0023 / IP44 BB1-0931-0026 / IP67</p>	<p>120x170x70</p>  <p>BB2-0921-0023 / IP44 BB2-0921-0026 / IP67</p> <p>Halogen Free BB1-0921-0023 / IP44 BB1-0921-0026 / IP67</p>	<p>120x170x140</p>  <p>BB2-0931-0063 / IP44 BB2-0931-0066 / IP67</p> <p>Halogen Free BB1-0931-0063 / IP44 BB1-0931-0066 / IP67</p>	<p>120x170x140</p>  <p>BB2-0921-0063 / IP44 BB2-0921-0066 / IP67</p> <p>Halogen Free BB1-0921-0063 / IP44 BB1-0921-0066 / IP67</p>	<p>120x255x80</p>  <p>BB2-0631-0003 / IP44 BB2-0631-0006 / IP67</p> <p>Halogen Free BB1-0631-0003 / IP44 BB1-0631-0006 / IP67</p>
<p>120x225x140</p>  <p>BB2-0631-0063 / IP44 BB2-0631-0066 / IP67</p> <p>Halogen Free BB1-0631-0063 / IP44 BB1-0631-0066 / IP67</p>	<p>120x224x140</p>  <p>BB2-0621-0063 / IP44 BB2-0621-0066 / IP67</p> <p>Halogen Free BB1-0621-0063 / IP44 BB1-0621-0066 / IP67</p>	<p>210x300x90</p>  <p>BB2-0731-0003 / IP44 BB2-0731-0006 / IP67</p> <p>Halogen Free BB1-0731-0003 / IP44 BB1-0731-0006 / IP67</p>	<p>220x300x140</p>  <p>BB2-0731-0063 / IP44 BB2-0731-0066 / IP67</p> <p>Halogen Free BB1-0731-0063 / IP44 BB1-0731-0066 / IP67</p>	<p>220x300x140</p>  <p>BB2-0721-0063 / IP44 BB2-0721-0066 / IP67</p> <p>Halogen Free BB1-0721-0063 / IP44 BB1-0721-0066 / IP67</p>	

Product Code	Descriptions	Product Dimensions (mm)	IP	Box	Pack
BB1-0431-0086	Screw Lid	95x95x60	IP67	8	64
BB1-0521-0066	Transparent Cover	120x120x140	IP67	1	60
BB1-0531-0006	Screw Lid	120x120x70	IP67	6	48
BB1-0531-0066	Screw Lid	120x120x140	IP67	1	60
BB1-0621-0066	Transparent Cover	120x224x140	IP67	1	30
BB1-0631-0006	Screw Lid	120x255x80	IP67	10	0
BB1-0631-0066	Screw Lid	120x224x140	IP67	1	30
BB1-0721-0066	Transparent Cover	220x300x140	IP67	1	10
BB1-0731-0006	Screw Lid	210x300x90	IP67	4	0
BB1-0731-0066	Screw Lid	220x300x140	IP67	1	10
BB1-0921-0026	Transparent Cover	120x170x70	IP67	15	0
BB1-0921-0066	Transparent Cover	120x170x140	IP67	1	40
BB1-0931-0026	Screw Lid	120x170x70	IP67	15	0
BB1-0931-0066	Screw Lid	120x170x140	IP67	1	40
BB1-1021-0076	Transparent Cover	340x340x160	IP67	1	6
BB1-1031-0076	Screw Lid	340x340x160	IP67	1	6
BB1-1121-0056	Transparent Cover	110x110x100	IP67	4	48
BB1-1131-0056	Screw Lid	110x110x100	IP67	4	48
BB1-1221-0096	Transparent Cover	300x535x150	IP67	2	0
BB1-1231-0026	Screw Lid	110x110x70	IP67	6	48
BB1-1231-0096	Screw Lid	300x535x150	IP67	2	0
BB1-1331-0026	Screw Lid	110x150x70	IP67	4	32
BB1-1431-0006	Screw Lid	Diameter Ø80x45	IP67	16	128
BB1-1631-0026	Screw Lid	110x180x70	IP67	4	32
BB1-1531-0066	Screw Lid	200x500x140	IP67	1	4
BB1-1521-0066	Transparent Cover	200x500x140	IP67	1	4

Brand New  
Brand New  
Brand New

Ø80x45mm.  
Screw Lid



Halogen Free  
BB1-1431-0006 / IP67

340x340x160



Halogen Free  
BB1-1031-0073 / IP44  
BB1-1031-0076 / IP67

340x340x160



Halogen Free  
BB1-1021-0073 / IP44  
BB1-1021-0076 / IP67

300x535x150



Halogen Free  
BB1-1231-0092 / IP44  
BB1-1231-0096 / IP67

300x535x150



Halogen Free  
BB1-1221-0092 / IP44  
BB1-1221-0096 / IP67

200x500x140



Halogen Free  
BB1-1531-0063 / IP44  
BB1-1531-0066 / IP67

200x500x140

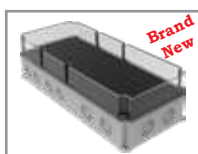

Halogen Free  
BB1-1521-0063 / IP44  
BB1-1521-0066 / IP67

# Plastic Enclosure Box IP67



Product Code	Descriptions	Product Dimensions (mm)	IP	Box	Pack
BB2-0431-0086	Screw Lid	95x95x60	IP67	8	64
BB2-0521-0066	Transparent Cover	120x120x140	IP67	1	60
BB2-0531-0006	Screw Lid	120x120x70	IP67	6	48
BB2-0531-0066	Screw Lid	120x120x140	IP67	1	60
BB2-0621-0066	Transparent Cover	120x224x140	IP67	1	30
BB2-0631-0006	Screw Lid	120x255x80	IP67	10	0
BB2-0631-0066	Screw Lid	120x224x140	IP67	1	30
BB2-0721-0066	Transparent Cover	220x300x140	IP67	1	10
BB2-0731-0006	Screw Lid	210x300x90	IP67	4	0
BB2-0731-0066	Screw Lid	220x300x140	IP67	1	10
BB2-0921-0026	Transparent Cover	120x170x70	IP67	15	0
BB2-0921-0066	Transparent Cover	120x170x140	IP67	1	40
BB2-0931-0026	Screw Lid	120x170x70	IP67	15	0
BB2-0931-0066	Screw Lid	120x170x140	IP67	1	40
BB2-1021-0076	Transparent Cover	340x340x160	IP67	1	6
BB2-1031-0076	Screw Lid	340x340x160	IP67	1	6
BB2-1121-0056	Transparent Cover	110x110x100	IP67	4	48
BB2-1131-0056	Screw Lid	110x110x100	IP67	4	48
BB2-1221-0096	Transparent Cover	300x535x150	IP67	2	0
BB2-1231-0026	Screw Lid	110x110x70	IP67	6	48
BB2-1231-0096	Screw Lid	300x535x150	IP67	2	0
BB2-1331-0026	Screw Lid	110x150x70	IP67	4	32
BB2-1431-0006	Screw Lid	Diameter Ø80x45	IP67	16	128
BB2-1631-0026	Screw Lid	110x180x70	IP67	4	32
BB2-1531-0066	Screw Lid	200x500x140	IP67	1	4
BB2-1521-0066	Transparent Cover	200x500x140	IP67	1	4

Brand New  
Brand New  
Brand New

Ø80x45mm.  
Screw Lid



BB2-1431-0006 / IP67

340x340x160



BB2-1031-0073 / IP44  
BB2-1031-0076 / IP67

340x340x160



BB2-1021-0073 / IP44  
BB2-1021-0076 / IP67

300x535x150



BB2-1231-0092 / IP44  
BB2-1231-0096 / IP67

300x535x150



BB2-1221-0092 / IP44  
BB2-1221-0096 / IP67

200x500x140



Halogen Free  
BB2-1531-0063 / IP44  
BB2-1531-0066 / IP67

200x500x140

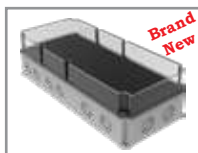

Halogen Free  
BB2-1521-0063 / IP44  
BB2-1521-0066 / IP67

Product Code	Product Dimensions (mm)	IP	Box	Pack
BB3-2103-1017	65x65x40	IP67	1	16
BB3-2113-1017	65x100x40	IP67	1	10
BB3-2123-1107	100x130x75	IP67	1	24
BB3-2131-0087	80x80x60	IP67	1	65
BB3-2131-0097	80x80x73	IP67	1	45
BB3-2531-0407	100x100x90	IP67	1	28
BB3-2133-1047	130x230x90	IP67	1	9
BB3-2143-1047	160x160x90	IP67	1	12
BB3-2153-1047	160x260x90	IP67	1	7
BB3-2150-1047	160x260x90 (Hinged)	IP67	1	7
BB3-2160-1047	190x350x90 (Hinged)	IP67	1	3
BB3-2163-1047	190x350x90	IP67	1	3
BB3-2170-1057	250x250x110 (Hinged)	IP67	1	4
BB3-2173-1057	250x250x110	IP67	1	4
BB3-2180-1067	310x400x140 (Hinged)	IP67	1	2
BB3-2183-1067	310x400x140	IP67	1	2
BB3-2190-1067	230x330x140 (Hinged)	IP67	1	1
BB3-2193-1067	230x330x140	IP67	1	1
BB3-2231-0097	80x130x73	IP67	1	35
BB3-2331-0097	80x170x73	IP67	1	22
BB3-2431-0097	80x230x73	IP67	1	15
BB3-2531-0107	100x100x75	IP67	1	30
BB3-2631-0047	130x130x90	IP67	1	18
BB3-2731-0047	130x190x90	IP67	1	12
BB3-2831-0047	170x190x90	IP67	1	1
BB3-2931-0047	190x250x90	IP67	1	1

65x65x40



BB3-2103-1017

65x100x40



BB3-2113-1017

80x80x60



BB3-2131-0087

80x80x73



BB3-2131-0097

80x130x73



BB3-2231-0097

80x170x73



BB3-2331-0097

80x230x73



BB3-2431-0097

100x100x75



BB3-2531-0107

100x130x75



BB3-2123-1107

130x130x90



BB3-2631-0047

130x190x90

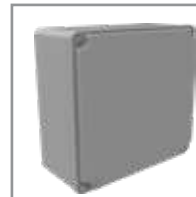

BB3-2731-0047

130x230x90



BB3-2133-1047

160x160x90



BB3-2143-1047

160x260x90



BB3-2153-1047

170x190x90



BB3-2831-0047

190x250x90



BB3-2931-0047

190x350x90

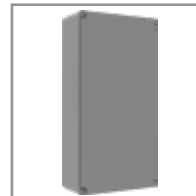

BB3-2163-1047

190x350x90 Hinged



BB3-2160-1047

250x250x110



BB3-2173-1057

250x250x110 Hinged



BB3-2170-1057

310x400x140



BB3-2183-1067

310x400x140 Hinged



BB3-2180-1067

230x330x140



BB3-2193-1067

230x330x140 Hinged



BB3-2190-1067





5 YEAR  
WARRANTY

### Button Box

Aluminum - Plastic



Product Code	Descriptions	IP	Box	Pack
BT3-1000-0002	Button Box For Single Button (Black)	IP44	16	128
BT3-1011-0002	Emergency Push Button Box (Yellow)	IP44	16	128
BT3-2000-0002	Button Box For Double Button (Black)	IP44	12	96
BT3-3000-0002	Button Box For Triple Button (Black)	IP44	8	64
BT3-4000-0002	Button Box For Quad Button (Black)	IP44	6	48
BT3-5000-0002	Button Box For Five Button (Black)	IP44	6	48

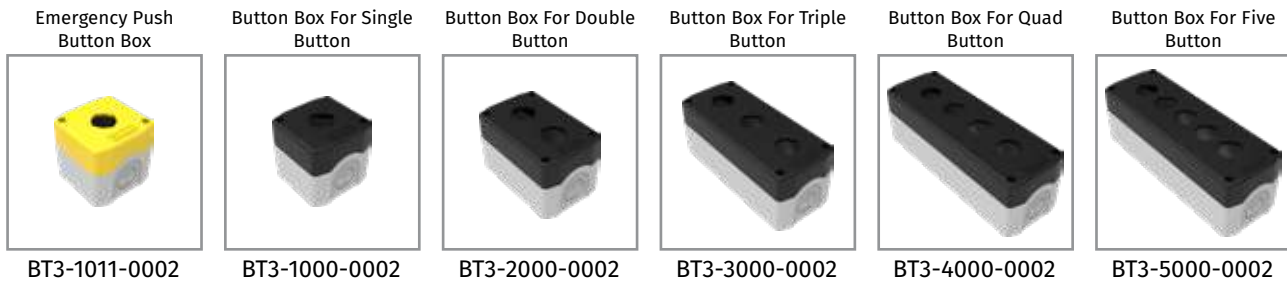

Product Code	Descriptions	IP	Box	Pack
BT3-1000-0006	Button Box For Single Button (Black)	IP67	16	128
BT3-1011-0006	Emergency Push Button Box (Yellow)	IP67	16	128
BT3-2000-0006	Button Box For Double Button (Black)	IP67	12	96
BT3-3000-0006	Button Box For Triple Button (Black)	IP67	8	64
BT3-4000-0006	Button Box For Quad Button (Black)	IP67	6	48
BT3-5000-0006	Button Box For Five Button (Black)	IP67	6	48

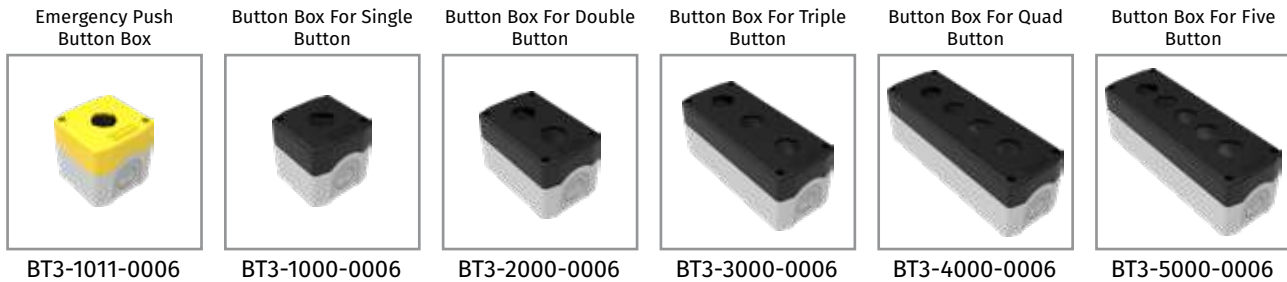

Product Code	Descriptions	IP	Box	Pack
BT3-1020-0002	10A. Pacco Switch Box	IP44	16	128
BT3-2030-0002	25A. Pacco Switch Box	IP44	12	96
BT3-4040-0002	Fuse and Socket Box	IP44	6	48
BT3-4050-0002	1/16A. 220V. Fuse and with Socket Box	IP44	6	48
BT3-4060-0002	1/16A. 220V. Signal Fuse and with Socket Box	IP44	6	48



# Aluminum Button Box

Product Code	Descriptions	Product Dimensions (mm)	IP	Box	Pack
BT4-1001-0007	Button Box For Single Button	80x80x60	IP67	1	65
BT4-1001-0017	Button Box For Single Button	80x80x73	IP67	1	45
BT4-2001-0007	Button Box For Double Button	80x130x73	IP67	1	35
BT4-3001-0007	Button Box For Triple Button	80x170x73	IP67	1	22
BT4-3001-0017	Button Box For Quad Button	80x170x73	IP67	1	22
BT4-4001-0007	Button Box For Quintet Button	80x230x73	IP67	1	15
BT4-4001-0017	Button Box For Six Button	80x230x73	IP67	1	15

Button Box For Single Button  
80x80x60



BT4-1001-0007

Button Box For Single Button  
80x80x73



BT4-1001-0017

Button Box For Double Button  
80x130x73

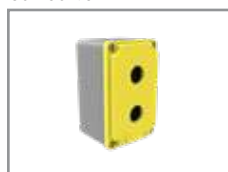

BT4-2001-0007

Button Box For Triple Button  
80x170x73



BT4-3001-0007

Button Box For Quad Button  
80x170x73

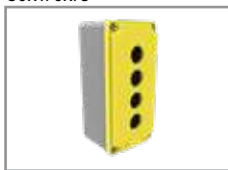

BT4-3001-0017

Button Box For Quintet Button  
80x230x73



BT4-4001-0007

Button Box For Six Button  
80x230x73



BT4-4001-0017

Product Code	Descriptions	Product Dimensions (mm)	IP	Box	Pack
BT4-1071-0007	Button Box For Single Button Protected	80x80x60	IP67	1	65
BT4-1071-0017	Button Box For Single Button Protected	80x80x73	IP67	1	45
BT4-2071-0007	Button Box For Double Button Protected	80x130x73	IP67	1	35
BT4-3071-0007	Button Box For Triple Button Protected	80x170x73	IP67	1	22
BT4-3071-0017	Button Box For Quad Button Protected	80x170x73	IP67	1	22
BT4-4071-0007	Button Box For Quintet Button Protected	80x230x73	IP67	1	15
BT4-4071-0017	Button Box For Six Button Protected	80x230x73	IP67	1	15

Button Box For Single Button Protected  
80x80x60



BT4-1071-0007

Button Box For Single Button Protected  
80x80x73



BT4-1071-0017

Button Box For Double Button Protected  
80x130x73



BT4-2071-0007

Button Box For Triple Button Protected  
80x170x73



BT4-3071-0007

Button Box For Quad Button Protected  
80x170x73



BT4-3071-0017

Button Box For Quintet Button Protected  
80x230x73



BT4-4071-0007

Button Box For Six Button Protected  
80x230x73



BT4-4071-0017

BRAND  
NEW



## ATEX EX-PROOF PRODUCT FEATURES

- ▶ Suitable for **ZONE 1 & ZONE 2** in flammable and explosive gas environments.
- ▶ Suitable for **ZONE 21 & ZONE 22** in flammable and explosive dust environments.
- ▶ Electrostatic powder coating.
- ▶ Stainless steel captive screw system.
- ▶ Replaceable sealing gasket for easy maintenance.
- ▶ Internal and external grounding connection.
- ▶ IP67 protection class.
- ▶ High-impact resistant body.
- ▶ Operating temperature range:  $-20^{\circ}\text{C}$  to  $+60^{\circ}\text{C}$ .

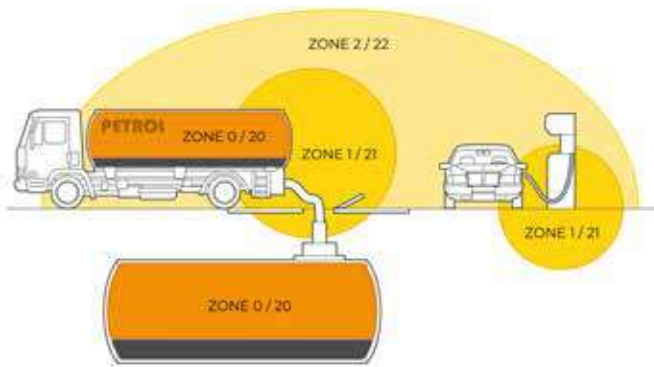

### Internal Grounding Connection Point

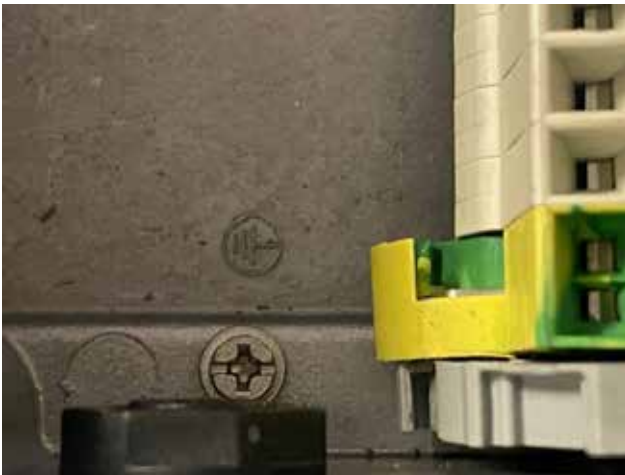

### External Grounding Connection Point



BRAND  
NEW



5 YEAR  
WARRANTY

### Atex Ex-Proof Enclosure & Button Box

Aluminum



EX-Proof  
Enclosure & Button Box

**BRAND  
NEW**



# Atex Ex-Proof Aluminum Enclosure Box

Product Code	Product Dimensions (mm)	IP	Box	Pack
EXBB3-2103-1017	65X65X40	IP67	1	16
EXBB3-2113-1017	65X100X40	IP67	1	10
EXBB3-2123-1107	100X130X75	IP67	1	24
EXBB3-2131-0087	80x80x60	IP67	1	65
EXBB3-2131-0097	80x80x73	IP67	1	45
EXBB3-2133-1047	130X230X90	IP67	1	9
EXBB3-2143-1047	160X160X90	IP67	1	12
EXBB3-2153-1047	160X260X90	IP67	1	7
EXBB3-2150-1047	160X260X90 (Hinged)	IP67	1	7
EXBB3-2160-1047	190X350X90 (Hinged)	IP67	1	3
EXBB3-2163-1047	190X350X90	IP67	1	3
EXBB3-2170-1057	250X250X110 (Hinged)	IP67	1	4
EXBB3-2173-1057	250X250X110	IP67	1	4
EXBB3-2180-1067	310X400X140 (Hinged)	IP67	1	2
EXBB3-2183-1067	310X400X140	IP67	1	2
EXBB3-2190-1067	230X330X140 (Hinged)	IP67	1	1
EXBB3-2193-1067	230X330X140	IP67	1	1
EXBB3-2231-0097	80x130x73	IP67	1	35
EXBB3-2331-0097	80x170x73	IP67	1	22
EXBB3-2431-0097	80x230x73	IP67	1	15
EXBB3-2531-0107	100x100x75	IP67	1	30
EXBB3-2631-0047	130x130x90	IP67	1	18
EXBB3-2731-0047	130x190x90	IP67	1	12
EXBB3-2831-0047	170x190x90	IP67	1	1
EXBB3-2931-0047	190x250x90	IP67	1	1



# Atex Ex-Proof Aluminum Button Box



BRAND  
NEW

Product Code	Descriptions	Product Dimensions (mm)	IP	Box	Pack
EXBT4-1001-0007	Button Box For Single Button	80x80x60	IP67	1	65
EXBT4-1001-0017	Button Box For Single Button	80x80x73	IP67	1	45
EXBT4-2001-0007	Button Box For Double Button	80x130x73	IP67	1	35
EXBT4-3001-0007	Button Box For Triple Button	80x170x73	IP67	1	22
EXBT4-3001-0017	Button Box For Quad Button	80x170x73	IP67	1	22
EXBT4-4001-0007	Button Box For Quintet Button	80x230x73	IP67	1	15
EXBT4-4001-0017	Button Box For Six Button	80x230x73	IP67	1	15

Button Box For Single Button  
80x80x60



EXBT4-1001-0007

Button Box For Single Button  
80x80x73



EXBT4-1001-0017

Button Box For Double Button  
80x130x73



EXBT4-2001-0007

Button Box For Triple Button  
80x170x73



EXBT4-3001-0007

Button Box For Quad Button  
80x170x73



EXBT4-3001-0017

Button Box For Quintet Button  
80x230x73

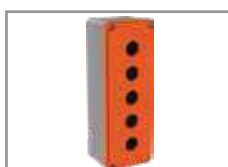

EXBT4-4001-0007

Button Box For Six Button  
80x230x73



EXBT4-4001-0017

Product Code	Descriptions	Product Dimensions (mm)	IP	Box	Pack
EXBT4-1071-0007	Button Box For Single Button Protected	80x80x60	IP67	1	65
EXBT4-1071-0017	Button Box For Single Button Protected	80x80x73	IP67	1	45
EXBT4-2071-0007	Button Box For Double Button Protected	80x130x73	IP67	1	35
EXBT4-3071-0007	Button Box For Triple Button Protected	80x170x73	IP67	1	22
EXBT4-3071-0017	Button Box For Quad Button Protected	80x170x73	IP67	1	22
EXBT4-4071-0007	Button Box For Quintet Button Protected	80x230x73	IP67	1	15
EXBT4-4071-0017	Button Box For Six Button Protected	80x230x73	IP67	1	15

Button Box For Single  
Button Protected  
80x80x60



EXBT4-1071-0007

Button Box For Single  
Button Protected  
80x80x73



EXBT4-1071-0017

Button Box For Double  
Button Protected  
80x130x73



EXBT4-2071-0007

Button Box For Triple  
Button Protected  
80x170x73



EXBT4-3071-0007

Button Box For Quad  
Button Protected  
80x170x73



EXBT4-3071-0017

Button Box For Quintet  
Button Protected  
80x230x73



EXBT4-4071-0007

Button Box For Six Button  
Protected  
80x230x73



EXBT4-4071-0017

EX-Proof  
Enclosure & Button Box



SPECIAL

**IP67**  
CABLE REEL SERIES

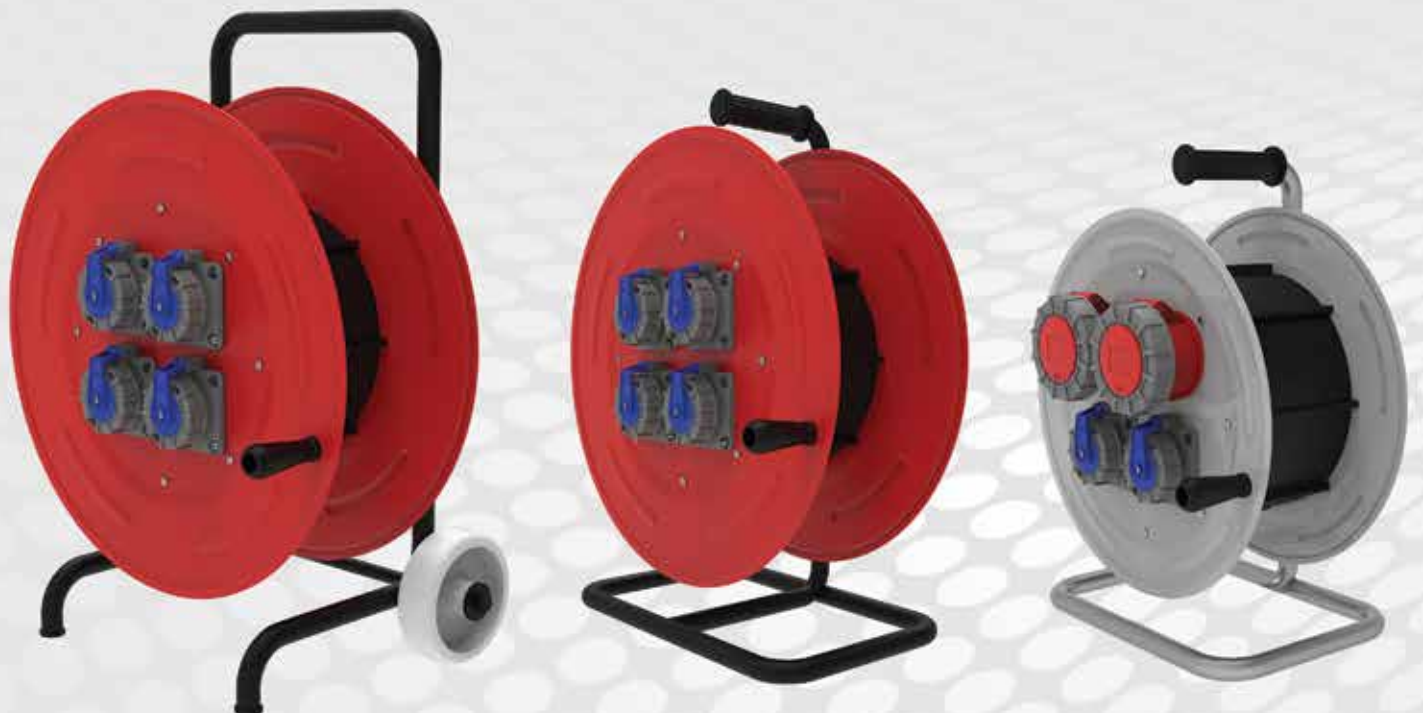





**5 YEAR  
WARRANTY**

### **Cable Reel**

*Metal - Plastic*



## BEMIS CABLE REEL CAPACITY TABLE

Cable Reel Model	CABLE SECTION AND LENGTH (meters)											
	3x1.5tr	3x2.5tr	3x4tr	3x6tr	4x1.5tr	4x2.5tr	4x4tr	4x6tr	5x1.5tr	5x2.5tr	5x4tr	5x6tr
<b>BM1</b>	25	15	13	10								
<b>BM2</b>	50	30	25	15								
<b>BM3</b>	70	50	35	25								
<b>BM4</b>	80	60	40	35	70	45	40	25	60	40	25	20
<b>BM5</b>	170	130	100	90	150	120	95	70	120	100	75	40
<b>BM6</b>	170	130	100	90	150	120	95	70	120	100	75	40
<b>BM7</b>	15	10										
<b>BM8</b>	25	20	15	10								
<b>BM9</b>	50	35	25	20								

Table is calculated based on H05VF-F cable outer diameter. Data may vary depending on the cable brand and user.

### METAL CABLE REEL FEATURES

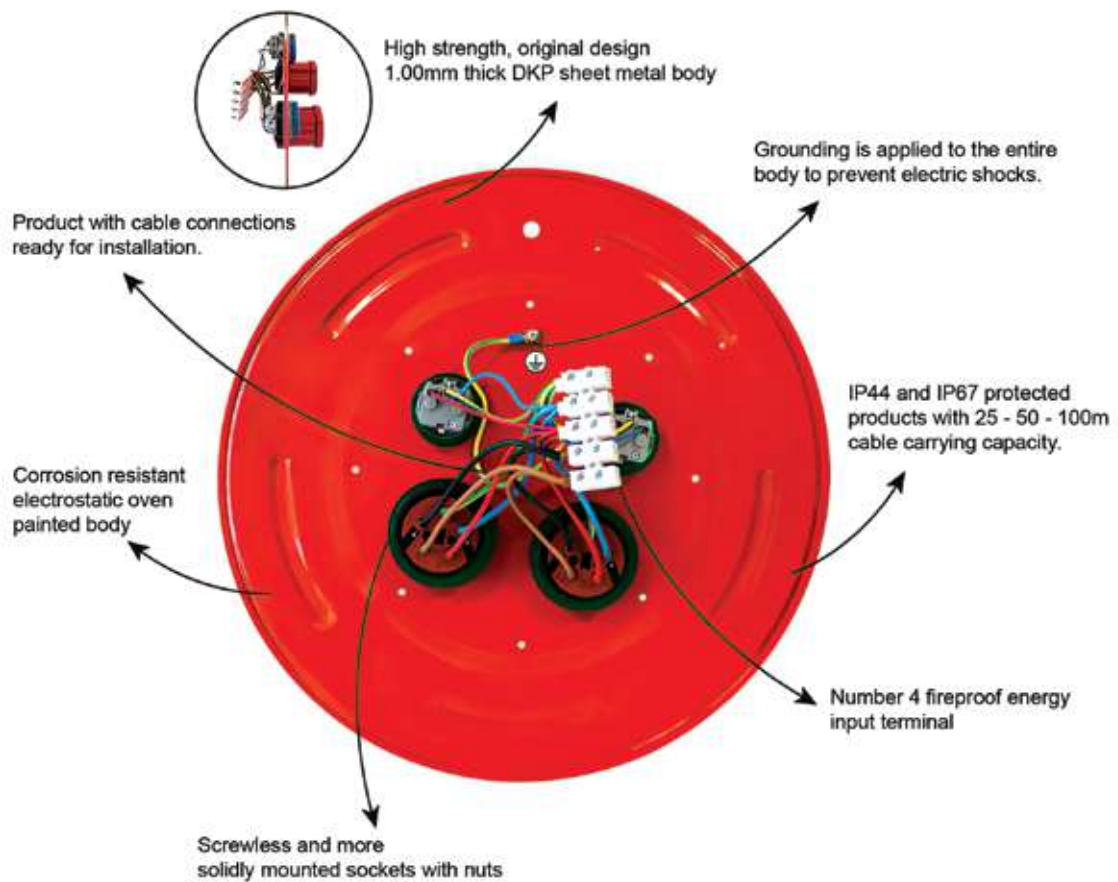



Plastic

4 Pcs. 1/16A. 220V. Socket  
3x1,5mm TTR 15 Mt. Capacity  
Plastic Cable Reel



BM7-1103-0000

4 Pcs. 1/16A. 220V. Socket  
3x1,5mm TTR 15 Mt. Cable  
Plastic Cable Reel



BM7K1103-0000

Plastic

4 Pcs. 1/16A. 220V. Socket  
3x1,5mm TTR 25 Mt. Capacity  
Plastic Cable Reel



BM8-2103-0000

4 Pcs. 1/16A. 220V. Socket  
3x1,5mm TTR 25 Mt. Cable  
Plastic Cable Reel



BM8K2103-0000

4 Pcs. 1/16A. 220V. Socket  
3x1,5mm TTR 25 Mt. Capacity  
Thermal Fuse Plastic Cable Reel



BM8-2104-0000

4 Pcs. 1/16A. 220V. Socket  
3x1,5mm TTR 25 Mt. Cable  
Thermal Fuse Plastic Cable Reel



BM8K2104-0000

Plastic

4 Pcs. 1/16A. 220V. Socket  
3x1,5mm TTR 50 Mt. Capacity  
Plastic Cable Reel



BM9-3103-0000

4 Pcs. 1/16A. 220V. Socket  
3x1,5mm TTR 50 Mt. Cable  
Plastic Cable Reel



BM9K3103-0000

4 Pcs. 1/16A. 220V. Socket  
3x1,5mm TTR 50 Mt. Capacity  
Thermal Fuse Plastic Cable Reel



BM9-3104-0000

4 Pcs. 1/16A. 220V. Socket  
3x1,5mm TTR 50 Mt. Cable  
Thermal Fuse Plastic Cable Reel



BM9K3104-0000

Plastic

3 Pcs. 1/16A. 220V. IP54 Socket  
3x1,5mm TTR 25 Mt. Capacity  
Thermal Fuse Plastic Cable Reel



BM8-2357-0004

3 Pcs. 1/16A. 220V. IP54 Socket  
3x1,5mm TTR 50 Mt. Capacity  
Thermal Fuse Plastic Cable Reel



BM9-3357-0004

Metal

3x1,5mm TTR 25 Mt. Capacity with  
Protection Cover Metal Cable Reel



BM1-2102-0000

4 Pcs. 1/16A. 220V. Socket  
3x1,5mm TTR 25 Mt. Capacity  
Metal Cable Reel



BM1-2103-0000

4 Pcs. 1/16A. 220V. Socket  
3x1,5mm TTR 25 Mt. Cable  
Metal Cable Reel





BM1K2103-0000





**Metal**

<p>3x1,5mm TTR 50 Mt. Capacity with Protection Cover Metal Cable Reel</p>  <p>BM2</p> <p>BM2-3102-0000</p>	<p>4 Pcs. 1/16A. 220V. Socket 3x1,5mm TTR 50 Mt. Capacity Metal Cable Reel</p>  <p>BM2</p> <p>BM2-3103-0000</p>	<p>4 Pcs. 1/16A. 220V. Socket 3x2,5mm TTR 50 Mt. Cable Metal Cable Reel</p>  <p>BM2</p> <p>BM2K3103-0000</p>	<p>4 Pcs. 1/16A. 220V. Socket 3x2,5mm TTR 25 Mt. Cable Metal Cable Reel</p>  <p>BM2</p> <p>BM2K3103-0022</p>
---	--	--	---

**Metal**

<p>3x2,5mm TTR 50 Mt. Capacity with Protection Cover Metal Cable Reel</p>  <p>BM3</p> <p>BM3-4102-0000</p>	<p>4 Pcs. 1/16A. 220V. Socket 3x2,5mm TTR 50 Mt. Capacity Metal Cable Reel</p>  <p>BM3</p> <p>BM3-4403-0000</p>	<p>3 Pcs. 1/16A. 220V. Socket 3x2,5mm TTR 50 Mt. Capacity Metal Cable Reel</p>  <p>BM3</p> <p>BM3-4303-0000</p>
---	--	---





**Metal**

<p>5x2,5mm TTR 40 Mt. Capacity Metal Cable Reel</p>  <p>BM4</p> <p>BM4-5000-0000</p>	<p>5x2,5mm TTR 40 Mt. Capacity with Protection Cover Metal Cable Reel</p>  <p>BM4</p> <p>BM4-5102-0000</p>	<p>6 Pcs. 1/16A. 220V. Socket 5x2,5mm TTR 40 Mt. Capacity Metal Cable Reel</p>  <p>BM4</p> <p>BM4-5603-0000</p>	<p>2 Pcs. 1/16A. 220V. 1 Pc. 3/25A. 380V. Socket 5x2,5mm TTR 40 Mt. Capacity Metal Cable Reel</p>  <p>BM4</p> <p>BM4-5203-1060</p>
---	---	---	---

**Metal**

<p>Empty 5x2,5mm TTR 50 Mt. Capacity Metal Cable Reel</p>  <p>BM5</p> <p>BM5-6000-0000</p>	<p>4 Pcs. 1/16A. 220V. IP67 Socket 5x2,5mm TTR 50 Mt. Capacity Metal Cable Reel</p>  <p>BM5</p> <p>BM5-6431-0000</p>	<p>2 Pcs. 1/16A. 220V. 1 Pc. 5/32A. 380V. 1 Pc. 5/16A. 380V. IP67 Socket 5x2,5mm TTR 50 Mt. Capacity Metal Cable Reel</p>  <p>BM5</p> <p>BM5-6231-1611</p>	<p>3 Pcs. 1/16A. 220V. Socket 5x2,5mm TTR 50 Mt. Capacity Metal Cable Reel</p>  <p>BM5</p> <p>BM5-6303-0000</p>
---	---	--	--

**Metal**

<p>Empty 5x2,5mm TTR 100 Mt. Capacity Portable Metal Cable Reel</p>  <p>BM6</p> <p>BM6-7000-0000</p>	<p>3 Pcs. 1/16A. 220V. Socket 5x2,5mm TTR 100 Mt. Capacity Portable Metal Cable Reel</p>  <p>BM6</p> <p>BM6-7303-0000</p>	<p>2 Pcs. 1/16A. 220V. 2 Pcs. 5/32A. 380V. IP67 Socket 5x2,5mm TTR 100 Mt. Capacity Portable Metal Cable Reel</p>  <p>BM6</p> <p>BM6-7231-2610</p>	<p>4 Pcs. 1/16A. 220V. IP67 Socket 5x2,5mm TTR 100 Mt. Capacity Portable Metal Cable Reel</p>  <p>BM6</p> <p>BM6-7431-0000</p>
---	--	--	---

**3x1,5mm TTR 25m. Capacity**

Product Code	Descriptions	IP	Box	Pack
BM1-2102-0000	Metal Cable Reel 3x1,5mm TTR 25m. Cable Capacity with Protection Cover	IP44	1	0
BM1-2103-0000	1/16A. 4 Socket Metal Cable Reel 3x1,5mm TTR 25m. Capacity	IP44	1	0
BM1K2103-0000	1/16A. 4 Socket Metal Cable Reel 3x1,5mm TTR 25m. with Cable	IP44	1	0

**3x1,5mm TTR 50m. Capacity**

Product Code	Descriptions	IP	Box	Pack
BM2-3102-0000	Metal Cable Reel 3x1,5mm TTR 50m. Cable Capacity with Protection Cover	IP44	1	0
BM2-3103-0000	1/16A. 4 Socket Metal Cable Reel 3x1,5mm TTR 50m. Capacity	IP44	1	0
BM2K3103-0000	1/16A. 4 Socket Metal Cable Reel 3x1,5mm TTR 50m. with Cable	IP44	1	0
BM2K3103-0022	1/16A. 220V. 4 Pcs. Socket Metal Cable Reel 3x2,5mm TTR 25m. with Cable	IP44	1	0

**3x2,5mm TTR 50m. Capacity**

Product Code	Descriptions	IP	Box	Pack
BM3-4102-0000	Metal Cable Reel 3x2,5mm TTR 50m. Cable Capacity with Protection Cover	IP44	1	0
BM3-4108-2030	1/16A. 2 Pcs. 3/16A. 220V. 1 Pc. Socket Metal Cable Reel 3x2,5mm TTR 50m. Capacity	IP44	1	0
BM3-4203-0000	1/16A. 2 Pcs. Socket Metal Cable Reel 3x2,5mm TTR 50m. Capacity	IP44	1	0
BM3-4203-1060	1/16A. 220V. 2 Pcs. 3/25A. 380V. 1 Pc. Socket Metal Cable Reel 3x2,5mm TTR 50m. Capacity	IP44	1	0
BM3-4224-0000	3/16A. 24V. 2 Pcs. Socket Metal Cable Reel 3x2,5mm TTR 50m. Capacity	IP44	1	0
BM3-4303-0000	1/16A. 220V. 3 Pcs. Socket Metal Cable Reel 3x2,5mm TTR 50m. Capacity	IP44	1	0
BM3-4303-0004	1/16A. 220V. 3 Pcs. Socket Metal Cable Reel 3x2,5mm TTR 50m. Capacity Thernal Fuse	IP44	1	0
BM3-4321-0004	1/16A. 220V. 3 Pcs. French Socket Metal Cable Reel 3x2,5mm TTR 50m. Cap. Thernal Fuse	IP44	1	0
BM3-4357-0004	1/16A. 220V. IP54 3 Pcs. Socket Metal Cable Reel 3x2,5mm TTR 50m. Capacity Thernal Fuse	IP54	1	0
BM3-4403-0000	1/16A. 220V. 4 Pcs. Socket Metal Cable Reel 3x2,5mm TTR 50m. Capacity	IP44	1	0
BM3K4403-0000	1/16A. 220V. 4 Pcs. Socket Metal Cable Reel 3x2,5mm TTR 50m. with Cable	IP44	1	0

**5x2,5mm TTR 40m. Capacity**

Product Code	Descriptions	IP	Box	Pack
BM4-5000-0000	Metal Cable Reel Without Socket 5x2,5mm TTR 40m. Cable Capacity	IP44	1	0
BM4-5102-0000	Metal Cable Reel Without Socket 5x2,5mm TTR 40m. Cable Capacity with Protection Cover	IP44	1	0
BM4-5103-1160	1/16A. 220V. 1 Pc. 5/32A. 380V. 1 Pc. Socket Metal Cable Reel 5x2,5mm TTR 40m. Capacity	IP44	1	0
BM4-5103-2060	1/16A. 220V. 1 Pc. 3/25A. 380V. 2 Pcs. Socket Metal Cable Reel 5x2,5mm TTR 40m. Capacity	IP44	1	0
BM4-5112-2030	1/16A. 220V. 2 Pcs. 5/16A. 380V. 1 Pc. Socket Metal Cable Reel 5x2,5mm TTR 40m. Capacity	IP44	1	0
BM4-5203-1060	1/16A. 220V. 2 Pcs. 3/25A. 380V. 1 Pc. Socket Metal Cable Reel 5x2,5mm TTR 40m. Capacity	IP44	1	0
BM4-5203-1080	1/16A. 220V. 2 Pcs. 3/16A. 220V. 1 Pc. Socket Metal Cable Reel 5x2,5mm TTR 40m. Capacity	IP44	1	0
BM4-5203-1160	1/16A. 220V. 2 Pcs. 5/32A. 380V. 1 Pc. Socket Metal Cable Reel 5x2,5mm TTR 40m. Capacity	IP44	1	0
BM4-5203-2060	1/16A. 220V. 2 Pcs. 3/25A. 380V. 2 Pcs. Socket Metal Cable Reel 5x2,5mm TTR 40m. Capacity	IP44	1	0
BM4-5203-2080	1/16A. 220V. 2 Pcs. 3/16A. 220V. 2 Pcs. Socket Metal Cable Reel 5x2,5mm TTR 40m. Capacity	IP44	1	0
BM4-5203-2110	1/16A. 220V. 2 Pcs. 4/16A. 380V. 2 Pcs. Socket Metal Cable Reel 5x2,5mm TTR 40m. Capacity	IP44	1	0
BM4-5203-2120	1/16A. 220V. 2 Pcs. 5/16A. 380V. 2 Pcs. Socket Metal Cable Reel 5x2,5mm TTR 40m. Capacity	IP44	1	0
BM4-5203-2150	1/16A. 220V. 2 Pcs. 4/32A. 380V. 2 Pcs. Socket Metal Cable Reel 5x2,5mm TTR 40m. Capacity	IP44	1	0
BM4-5203-2160	1/16A. 220V. 2 Pcs. 5/32A. 380V. 2 Pcs. Socket Metal Cable Reel 5x2,5mm TTR 40m. Capacity	IP44	1	0
BM4-5303-0000	1/16A 220V IP44 3 Pcs. Socket Metal Cable Reel 5x2,5mm TTR 40m. Capacity	IP44	1	0
BM4-5303-1060	1/16A. 220V. 3 Pcs. 3/25A. 380V. 1 Pc. Socket Metal Cable Reel 5x2,5mm TTR 40m. Capacity	IP44	1	0
BM4-5303-1110	1/16A. 220V. 3 Pcs. 4/16A. 380V. 1 Pc. Socket Metal Cable Reel 5x2,5mm TTR 40m. Capacity	IP44	1	0
BM4-5303-1120	1/16A. 220V. 3 Pcs. 5/16A. 380V. 1 Pc. Socket Metal Cable Reel 5x2,5mm TTR 40m. Capacity	IP44	1	0
BM4-5303-1150	1/16A. 220V. 3 Pcs. 4/32A. 380V. 1 Pc. Socket Metal Cable Reel 5x2,5mm TTR 40m. Capacity	IP44	1	0
BM4-5303-1160	1/16A. 220V. 3 Pcs. 5/32A. 380V. 1 Pc. Socket Metal Cable Reel 5x2,5mm TTR 40m. Capacity	IP44	1	0
BM4-5603-0000	1/16A. 220V. 6 Pcs. Socket Metal Cable Reel 5x2,5mm TTR 40m. Capacity	IP44	1	0
BM4-5031-0000	Metal Cable Reel Without Socket 5x2,5mm TTR 40m. Cable Capacity	IP67	1	0
BM4-5231-1610	1/16A. 220V. 2 Pcs. 5/32A. 380V. 1 Pc. IP67 Socket Metal Cable Reel 5x2,5mm TTR 40m. Capacity	IP67	1	0
BM4-5431-0000	1/16A. 220V. 4 Pcs. IP67 Socket Metal Cable Reel 5x2,5mm TTR 40m. Capacity	IP67	1	0
BM4-5231-2610	1/16A. 220V. 2 Pcs. 5/32A. 380V. 2 Pcs. IP67 Socket Metal Cable Reel 5x2,5mm TTR 40m. Capacity	IP67	1	0
BM4-5231-1470	1/16A. 220V. 2 Pcs. 5/16A. 380V. 1 Pc. IP67 Socket Metal Cable Reel 5x2,5mm TTR 40m. Capacity	IP67	1	0
BM4-5231-1611	1/16A. 220V. 2 Pcs. 5/32A. 380V. 1 Pc. 5/16A. 380V. 1 Pc. IP67 Socket Metal 5x2,5mm TTR 40m. Cap.	IP67	1	0

## 5x2,5mm TTR 50m. Capacity

Product Code	Descriptions	IP	Box	Pack
BM5-6000-0000	Metal Cable Reel Without Socket 5x2,5mm TTR 50m. Cable Capacity	IP44	1	0
BM5-6102-0000	Metal Cable Reel Without Socket 5x2,5mm TTR 50m. Cable Capacity with Protection Cover	IP44	1	0
BM5-6103-1161	1/16A. 220V. 1 Pc. 5/16A. 380V. 1 Pc. 5/32A. 380V. 1 Pc. Socket Metal Cable Reel 5x2,5mm TTR 50m. Cap.	IP44	1	0
BM5-6103-2060	1/16A. 220V. 1 Pc. 3/25A. 380V. 2 Pcs. Socket Metal Cable Reel 5x2,5mm TTR 50m. Capacity	IP44	1	0
BM5-6116-0000	5/32A. 380V. 1 Pc. Socket Metal Cable Reel 5x2,5mm TTR 50m. Capacity	IP44	1	0
BM5-6203-1200	1/16A. 220V. 2 Pcs. 5/63A. 380V. 1 Pc. Socket Metal Cable Reel 5x2,5mm TTR 50m. Capacity	IP44	1	0
BM5-6203-2150	1/16A. 220V. 2 Pcs. 4/32A. 380V. 2 Pcs. Socket Metal Cable Reel 5x2,5mm TTR 50m. Capacity	IP44	1	0
BM5-6203-2160	1/16A. 220V. 2 Pcs. 5/32A. 380V. 2 Pcs. Socket Metal Cable Reel 5x2,5mm TTR 50m. Capacity	IP44	1	0
BM5-6212-2030	1/16A. 220V. 2 Pcs. 5/16A. 380V. 2 Pcs. Socket Metal Cable Reel 5x2,5mm TTR 50m. Capacity	IP44	1	0
BM5-6303-0000	1/16A. 220V. 3 Pcs. Socket Metal Cable Reel 5x2,5mm TTR 50m. Capacity	IP44	1	0
BM5-6303-1160	1/16A. 220V. 3 Pcs. 5/32A. 380V. 1 Pc. Socket Metal Cable Reel 5x2,5mm TTR 50m. Capacity	IP44	1	0
BM5-6304-0000	1/16A. 220V. Panel Mounted Socket 3 Pcs. Socket Metal Cable Reel 5x2,5mm TTR 50m. Capacity	IP44	1	0
BM5-6315-0000	4/32A. 380V. 3 Pcs. Socket Metal Cable Reel 5x2,5mm TTR 50m. Capacity	IP44	1	0
BM5-6316-0000	5/32A. 380V. 3 Pcs. Socket Metal Cable Reel 5x2,5mm TTR 50m. Capacity	IP44	1	0
BM5-6403-0000	1/16A. 220V. 4 Pcs. Socket Metal Cable Reel 5x2,5mm TTR 50m. Capacity	IP44	1	0
BM5-6031-0000	Metal Cable Reel Without Socket 5x2,5mm TTR 50m. Cable Capacity	IP67	1	0
BM5-6231-2610	1/16A. 220V. 2 Pcs. 5/32A. 380V. 2 Pcs. IP67 Socket Metal Cable Reel 5x2,5mm TTR 50m. Capacity	IP67	1	0
BM5-6231-1611	1/16A. 220V. 2 Pcs. 5/32A. 380V. 1 Pc. 5/16A. 380V. 1 Pc. IP67 Socket Metal Cable Reel 5x2,5mm TTR 50m. Cap.	IP67	1	0
BM5-6431-0000	1/16A. 220V. 4 Pcs. IP67 Socket Metal Cable Reel 5x2,5mm TTR 50m. Capacity	IP67	1	0

## 5x2,5mm TTR 100m. Capacity

Product Code	Descriptions	IP	Box	Pack
BM6-7000-0000	Portable Metal Cable Reel Without Socket 5x2,5mm TTR 100m. Capacity	IP44	1	0
BM6-7102-0000	Portable Metal Cable Reel Without Socket 5x2,5mm TTR 100m. Cable Capacity with Protection Cover	IP44	1	0
BM6-7103-1061	1/16A. 220V. 1 Pc. 3/25A. 380V. 1 Pc. 5/32A. 380V. 1 Pc. Socket 5x2,5mm TTR 100m. Cap. Portable Metal Cable Reel	IP44	1	0
BM6-7103-2060	1/16A. 220V. 1 Pc. 3/25A. 380V. 2 Pcs. Socket 5x2,5mm TTR 100m. Capacity Portable Metal Cable Reel	IP44	1	0
BM6-7203-1060	1/16A. 220V. 2 Pcs. 3/25A. 380V. 1 Pc. Socket 5x2,5mm TTR 100m. Capacity Portable Metal Cable Reel	IP44	1	0
BM6-7203-1061	1/16A. 220V. 2 Pcs. 3/25A. 380V. 1 Pc. 5/16A. 380V. 1 Pc. Socket 5x2,5mm TTR 100m. Cap. Portable Metal Cable Reel	IP44	1	0
BM6-7203-1062	1/16A. 220V. 2 Pcs. 3/25A. 380V. 1 Pc. 5/32A. 380V. 1 Pc. Socket 5x2,5mm TTR 100m. Cap. Portable Metal Cable Reel	IP44	1	0
BM6-7203-1120	1/16A. 220V. 2 Pcs. 5/16A. 380V. 1 Pc. Socket 5x2,5mm TTR 100m. Capacity Portable Metal Cable Reel	IP44	1	0
BM6-7203-1121	1/16A. 220V. 2 Pcs. 5/16A. 380V. 1 Pc. 5/32A. 380V. 1 Pc. Socket 5x2,5mm TTR 100m. Cap. Portable Metal Cable Reel	IP44	1	0
BM6-7203-1200	1/16A. 220V. 2 Pcs. 5/63A. 380V. 1 Pc. Socket 5x2,5mm TTR 100m. Capacity Portable Metal Cable Reel	IP44	1	0
BM6-7206-2030	1/16A. 220V. 2 Pcs. 3/25A. 380V. 2 Pcs. Socket 5x2,5mm TTR 100m. Capacity Portable Metal Cable Reel	IP44	1	0
BM6-7211-2030	1/16A. 220V. 2 Pcs. 4/16A. 380V. 2 Pcs. Socket 5x2,5mm TTR 100m. Capacity Portable Metal Cable Reel	IP44	1	0
BM6-7212-2030	1/16A. 220V. 2 Pcs. 5/16A. 380V. 2 Pcs. Socket 5x2,5mm TTR 100m. Capacity Portable Metal Cable Reel	IP44	1	0
BM6-7216-2030	1/16A. 220V. 2 Pcs. 5/32A. 380V. 2 Pcs. Socket 5x2,5mm TTR 100m. Capacity Portable Metal Cable Reel	IP44	1	0
BM6-7303-0000	1/16A. 220V. 3 Pcs. Socket 5x2,5mm TTR 100m. Capacity Portable Metal Cable Reel	IP44	1	0
BM6-7303-1160	1/16A. 220V. 3 Pcs. 5/32A. 380V. 1 Pc. Socket 5x2,5mm TTR 100m. Capacity Portable Metal Cable Reel	IP44	1	0
BM6-7403-0000	1/16A. 220V. 4 Pcs. Socket 5x2,5mm TTR 100m. Capacity Portable Metal Cable Reel	IP44	1	0
BM6-7406-0000	3/25A. 380V. 4 Pcs. Socket 5x2,5mm TTR 100m. Capacity Portable Metal Cable Reel	IP44	1	0
BM6-7031-0000	Portable Metal Cable Reel Without Socket 5x2,5mm TTR 100m. Capacity	IP67	1	0
BM6-7331-1610	1/16A. 220V. 3 Pcs. 5/32A. 380V. 1 Pc. IP67 Socket 5x2,5mm TTR 100m. Cap. Portable Metal Cable Reel	IP67	1	0
BM6-7231-2610	1/16A. 220V. 2 Pcs. 5/32A. 380V. 2 Pcs. IP67 Socket 5x2,5mm TTR 100m. Capacity Portable Metal Cable Reel	IP67	1	0
BM6-7231-1611	1/16A. 220V. 2 Pcs. 5/32A. 380V. 1 Pc. 5/16A. 380V. 1 Pc. IP67 Socket 5x2,5mm TTR 100m. Capacity Portable Metal Cable Reel	IP67	1	0
BM6-7431-0000	1/16A. 220V. 4 Pcs. IP67 Socket 5x2,5mm TTR 100m. Capacity Portable Metal Cable Reel	IP67	1	0

### 3x1,5mm TTR 15m. Capacity

Product Code	Descriptions	IP	Box	Pack
BM7-1103-0000	1/16A. 4 Socket Plastic Cable Reel 3x1,5mm TTR 15m. Capacity	IP44	1	0
BM7K1103-0000	1/16A. 4 Socket Plastic Cable Reel 3x1,5mm TTR 15m. Cable	IP44	1	0

### 3x1,5mm TTR 25m. Capacity

Product Code	Descriptions	IP	Box	Pack
BM8-2102-0000	Plastic Cable Reel Without Socket 3x1,5mm TTR 25m. Cable Capacity	IP44	1	0
BM8-2103-0000	1/16A. 4 Socket Plastic Cable Reel 3x1,5mm TTR 25m. Capacity	IP44	1	0
BM8-2104-0000	1/16A. 4 Socket Plastic Cable Reel 3x1,5mm TTR 25m. Capacity with Thermal Fuse	IP44	1	0
BM8-2305-0000	1/16A. 3 Panel Socket Plastic Cable Reel 3x1,5mm TTR 25m. Capacity	IP44	1	0
BM8-2306-0000	1/16A. 3 French Socket Plastic Cable Reel 3x1,5mm TTR 25m. Capacity	IP54	1	0
BM8-2357-0004	1/16A. 3 Panel Socket Plastic Cable Reel 3x1,5mm TTR 25m. Cap. with Thermal Fuse	IP44	1	0
BM8K2103-0000	1/16A. 4 Socket Plastic Cable Reel 3x1,5mm TTR 25m. Cable	IP44	1	0
BM8K2104-0000	1/16A. 4 Socket Plastic Cable Reel 3x1,5mm TTR 25m. Cable with Thermal Fuse	IP44	1	0

### 3x1,5mm TTR 50m. Capacity

Product Code	Descriptions	IP	Box	Pack
BM9-3102-0000	Plastic Cable Reel 3x1,5mm TTR 50m. Cable Capacity with Protection Cover	IP44	1	0
BM9-3103-0000	1/16A. 4 Socket Plastic Cable Reel 3x1,5mm TTR 50m. Capacity	IP44	1	0
BM9-3104-0000	1/16A. 4 Socket Plastic Cable Reel 3x1,5mm TTR 50m. Capacity with Thermal Fuse	IP44	1	0
BM9-3305-0000	1/16A. 3 Panel Socket Plastic Cable Reel 3x1,5mm TTR 50m. Capacity	IP54	1	0
BM9-3306-0000	1/16A. 3 French Socket Plastic Cable Reel 3x1,5mm TTR 50m. Capacity	IP44	1	0
BM9-3357-0004	1/16A. 3 Panel Socket Plastic Cable Reel 3x1,5mm TTR 50m. Cap. with Thermal Fuse	IP44	1	0
BM9K3103-0000	1/16A. 4 Socket Plastic Cable Reel 3x1,5mm TTR 50m. Cable	IP44	1	0
BM9K3104-0000	1/16A. 4 Socket Plastic Cable Reel 3x1,5mm TTR 50m. Cable with Thermal Fuse	IP44	1	0
BM9K3103-0022	1/16A. 4 Socket Plastic Cable Reel 3x2,5mm TTR 25m. Cable	IP44	1	0



BM7-1103-0000



BM8-2305-0000



BM9-3305-0000



## Spare Part

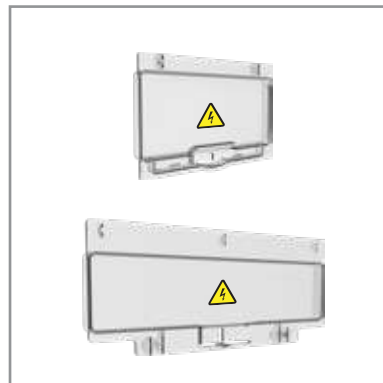

Product Code	Descriptions	Box	Pack
BAK-1000-0001	CEE Norm 3-4/32A. Plug Cover (IP67 Plug Protection Cover)	5	90
BAK-1000-0002	CEE Norm 5/32A. Plug Cover (IP67 Plug Protection Cover)	5	90
BAK-1000-0003	CEE Norm 63A. Plug Cover (IP67 Plug Protection Cover)	5	90
BAK-1000-0004	CEE Norm 125A. Plug Cover (IP67 Plug Protection Cover)	5	90
BAK-1000-0008	1/16A. 220V. Plug Cover (IP67 Plug Protection Cover)	5	90
BAK-1000-0010	CEE Norm 3/16A. 220V. Plug Cover (IP67 Plug Protection Cover)	5	90
BAK-1000-0011	CEE Norm 4/16A. 380V. Plug Cover (IP67 Plug Protection Cover)	5	90
BAK-1000-0012	CEE Norm 5/16A. 380V. Plug Cover (IP67 Plug Protection Cover)	5	90
BAK-1100-0010	3/16A. 90 Angled surface mounted plug spring lid		
BAK-1100-0011	4/16A. 90 Angled surface mounted plug spring lid		
BAK-1100-0012	5/16A. 90 Angled surface mounted plug spring lid		
BAK-1100-0013	3/4/5/32A. 90 Angled surface mounted plug spring lid		
BAK-2000-0100	75x75 frame and gasket		
BAK-2000-0200	83x90 frame and gasket		
BAK-2000-0500	1/16A Panel socket mounting bracket		
BAK-2000-0501	75x75 Frame Panel Mounted Socket mounting bracket		
BAK-2000-1007	1/16A. 220V. IP67 Plug/Socket Cover Tie	10	180
BAK-2100-0000	125A. 90 Angled Surface Mounted Socket Terminal Holder		
BAK-3000-1000	V5 Combination transparent fuse cover		
BAK-3000-1070	V7 Combination transparent fuse cover		
BAK-3000-2000	V10 Combination transparent fuse cover		
BAK-3000-2020	V12 Combination transparent fuse cover		
BAK-3000-3000	V17 Combination transparent fuse cover		
BAK-3000-5000	V26 Combination transparent fuse cover		
BAK-3007-0000	Combinations Terminal Holder		
BAK-5001-0000	1/16A. 220V. 4 socket for cable carriers		
BAK-5004-0000	Ear caps for cable carriers		
BAK-5005-0001	Pullers for cable carriers (Ø 19mm)		
BAK-5005-0002	Pullers for cable carriers (Ø 21mm)		
BAK-5009-0000	1/16A 3 Pcs. (No. 3 Cable Reel Hub)	4	
BAK-6000-0300	75x75 Polybox Hole Frame		
BAK-6000-0400	75x75 Polybox Imperforate Frame		
BAK-6000-0500	Polybox metal hunger		
BAK-3000-8000	8 Fuse Module		
BAK-3000-9000	12 Fuse Module		
BAK-5000-0000	Combination with cars		

Brand New  
Brand New  
Brand New  
Brand New



BAK-3000-8000  
8 Fuse Module



BAK-3000-9000  
12 Fuse Module



BAK-2000-0500  
1/16A Panel socket  
mounting bracket



Combination transparent fuse cover



BAK-3007-0000  
Combinations Terminal  
Holder



Angled surface  
mounted plug spring  
lid



Pullers for cable  
carriers



IP67 Plug/Socket  
Cover Tie



BAK-5001-0000  
1/16A. 220V. 4 socket for  
cable carriers



BAK-2100-0000  
125A. 90 Angled Surface  
Mounted Socket Terminal  
Holder



# FOREIGN TRADE

BEMIS Electricity, which is making successful strides toward becoming a global brand, has already been exported to more than 65 countries. Our goal is to increase exports to 70 countries by 2025.

BEMIS products reach global users through our showrooms, distributors, and agencies. We are committed to raising brand awareness worldwide by participating in international fairs and promotional events.



## ALL AROUND THE WORLD





## Respect for nature



*GES (Solar Energy System) electricity production.*



*ECO energy consumption, LED lighting and daylight saving system.*



*ECO water consumption, rainwater recovery and eco tap use.*



*Support for afforestation.*



*Recyclable raw material use and recovery system.*



*Waste control and minimum waste system is implemented in Bemis company.*



*Plug and socket recycling project.*

### Address:

Bursa Organize San. Böl.  
Yeşil Cad. No:19 NİLÜFER/BURSA  
TÜRKİYE

### Phone:

+90 224 363 30 65  
+90 542 773 72 94

### Mail:

trade@bemis.com.tr

### Web:

www.bemis.com.tr